

VR2940

# DVD Recorder + VCR

## User's Guide

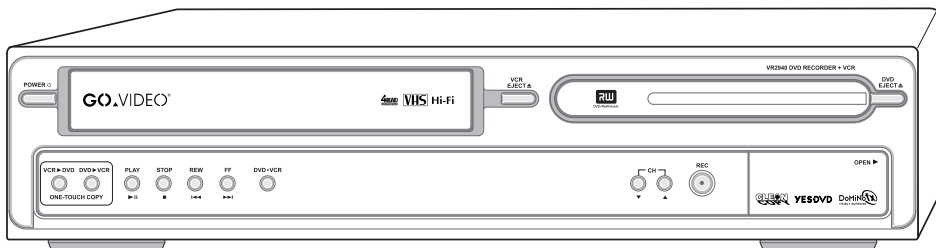

**CLEAN COPY** **YESDVD** **DoMiNo**  
VISIBLY SUPERIOR



**PROGRESSIVE SCAN**



**DOLBY DIGITAL**



**COMPACT disc DIGITAL AUDIO**



[www.govideo.com](http://www.govideo.com)

**GO.VIDEO®**

# Table of Contents

<b>Important Safeguards .....</b>	<b>3</b>	<b>5 - Editing .....</b>	<b>27</b>
<b>Important Safety Instructions...</b>	<b>4</b>	Disc Menu Options .....	27
<b>1 - Welcome.....</b>	<b>6</b>	Title Menu Options .....	28
Unpacking .....	6	DVD Edit Menu Options .....	29
Compatible Discs .....	6	<b>6 - Advanced Settings .....</b>	<b>30</b>
What is YesDVD? .....	6	Setup Menu Overview .....	30
What is DoMiNoFX? .....	6	Installation Settings .....	30
Front Panel Overview .....	7	Recording Settings .....	31
Front Panel Display Overview .....	8	Language Settings .....	32
Remote Control Overview .....	9	Preferences .....	33
Rear Panel Overview .....	11	Video Settings .....	33
<b>2 - Connections/Setup.....</b>	<b>12</b>	Audio Settings .....	34
Antenna/Cable Connections .....	12	Parental Controls .....	35
Basic TV Connections .....	13	System Information .....	37
Enhanced Video Connections .....	14	Restoring Defaults .....	37
Enhanced Audio Connections .....	15	<b>7 - Help.....</b>	<b>38</b>
Optional Equipment Connections .....	16	Troubleshooting.....	38
Initial Setup.....	17	Technical Specifications .....	40
<b>3 - Playback.....</b>	<b>18</b>	Disc Handling & Maintenance .....	41
Playing DVDs .....	18	YesDVD Terms & Conditions .....	42
Special DVD Playback Features .....	18	GoVideo Limited Warranty .....	44
Playing VHS Tapes .....	20	<b>Index .....</b>	<b>45</b>
Special VCR Playback Features .....	20		
Playing Audio/MP3 CDs .....	21		
Playing Picture CDs .....	21		
<b>4 - Recording.....</b>	<b>22</b>		
About YesDVD™ .....	22		
Creating a YesDVD .....	22		
Basic Recording .....	23		
One Touch Recording (OTR).....	23		
One Touch Copy.....	24		
Timer Recording.....	25		
Recording from an External Input.....	26		

©2004 GoVideo. All rights reserved. Printed in Korea.

"Dolby", "Pro Logic", and the double D symbol are trademarks of Dolby Laboratories. DTS and DTS Digital Out are registered trademarks of Digital Theater Systems, Inc. All other brand and product names are trademarks or registered trademarks of their respective companies.

Macrovision Notice - This product incorporates copyright protection technology that is protected by method claims of certain U.S. patents and other intellectual property rights owned by Macrovision Corporation and other rights owners. Use of this copyright protection technology must be authorized by Macrovision Corporation, and is intended for home and other limited viewing uses only unless otherwise authorized by Macrovision Corporation. Reverse engineering or disassembly is prohibited.

GoVideo shall not be liable for any errors contained herein or for any damages arising out of or related to this document or the information contained herein, even if GoVideo has been advised of the possibility of such damages. This document is intended for informational and instructional purposes only. GoVideo reserves the right to make changes in the specifications and other information contained in this document without prior notification. GoVideo disclaims any obligation to update the information contained herein.

## Important Safeguards



**CAUTION**  
RISK OF ELECTRIC SHOCK  
DO NOT OPEN



CAUTION: TO REDUCE THE RISK OF ELECTRIC SHOCK  
DO NOT REMOVE COVER  
NO USER-SERVICEABLE PARTS INSIDE  
REFER SERVICING TO QUALIFIED SERVICE PERSONNEL



This symbol is intended to alert the user to the presence of uninsulated dangerous voltage within the product's enclosure that may be of sufficient magnitude to constitute risk of fire or electric shock.



This symbol is intended to alert the user to the presence of important operating and maintenance instructions in the literature accompanying this product.

**WARNING: TO REDUCE THE RISK OF FIRE OR ELECTRIC SHOCK, DO NOT EXPOSE THIS APPLIANCE TO RAIN OR MOISTURE.**

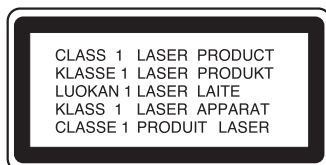

### CAUTION

TO PREVENT ELECTRIC SHOCK, MATCH WIDE BLADE OF PLUG TO WIDE SLOT, FULLY INSERT.

### ATTENTION

POUR ÉVITER LES CHOC ÉLECTRIQUES, INTRODUIRE LA LAME LA PLUS LARGE DE LA FICHE DANS LA BORNE CORRESPONDANTE DE LA PRISE ET POUSSER JUSQU'AU FOND.

### WARNING:

Do not install this equipment in a confined space such as a bookcase or similar unit.

### NOTE TO CABLE/TV INSTALLER:

This reminder is provided to call the cable TV system installer's attention to Article 820-40 of the National Electric Code (U.S.A.). The code provides guidelines for proper grounding and, in particular, specifies that the cable ground shall be connected to the grounding system of the building, as close to the point of the cable entry as practical.

### CAUTION:

This DVD Recorder+VCR employs a Laser System. To ensure proper use of this product, please read this owner's manual carefully and retain for future reference. Should the DVD Recorder+VCR require maintenance, contact an authorized service center. Use of controls, adjustments, or the performance of procedures other than those specified herein may result in hazardous radiation exposure. To prevent direct exposure to laser beam, do not try to open the enclosure. Visible laser radiation when open. DO NOT STARE INTO BEAM.

### CAUTION:

The apparatus should not be exposed to water (dripping or splashing) and no objects filled with liquids, such as vases, should be placed on the apparatus.

### FCC WARNING:

This equipment may generate or use radio frequency energy. Changes or modifications to this equipment may cause harmful interference unless the modifications are expressly approved in the instruction manual. The user could lose the authority to operate this equipment if an unauthorized change or modification is made.

### NOTE

This product has been tested and found to comply with the limits for a Class B digital device, pursuant to Part 15 of the FCC Rules. These limits are designed to provide reasonable protection against harmful interference when the product is operated in a residential installation. This product generates, uses, and can radiate radio frequency energy and, if not installed and used in accordance with the instruction manual, may cause harmful interference to radio communications. However, there is no guarantee that interference will not occur in a particular installation. If this product does cause harmful interference to radio or television reception, which can be determined by turning the product off and on, the user is encouraged to try to correct the interference by one or more of the following measures:

## Important Safeguards (cont.)

- Reorient or relocate the receiving antenna.
- Increase the separation between the product and receiver.
- Connect the product into an outlet on a circuit different from that to which the receiver is connected.
- Consult the dealer or an experienced radio/TV technician for help.

### FCC COMPLIANCE:

The responsible party for this product's compliance is: GoVideo, 7835 East McClain Drive, Scottsdale, AZ 85260, USA.

### SERIAL NUMBER:

The serial number is found on the back of the DVD Recorder+VCR. This number is for this unit only. You should record requested information here and retain this guide as a permanent record of your purchase.

Model No. \_\_\_\_\_

Serial No. \_\_\_\_\_

## Important Safety Instructions

- 1 Read Instructions** - All the safety and operating instructions should be read before the product is operated.
- 2 Retain Instructions** - The safety and operating instructions should be retained for future reference.
- 3 Heed Warnings**  
- All warnings on the product and in the operating instructions should be adhered to.
- 4 Follow Instructions**  
- All operating and using instructions should be followed.
- 5 Cleaning** - Unplug this product from the wall outlet before cleaning. Do not use liquid cleaners or aerosol cleaners. Use a damp cloth for cleaning.
- 6 Attachments** - Do not use attachments not recommended by the product manufacturer as they may cause hazards.
- 7 Water and Moisture** - Do not use this product near water - for example near a bath tub, wash bowl, kitchen sink, or laundry tub; in a wet basement; or near a swimming pool; and the like.
- 8 Accessories** - Do not place this product on an unstable cart, stand, tripod, bracket, or table. The product may fall, causing serious injury to a child or adult, and serious damage to the product. Use only with a cart, stand, tripod, bracket, or table recommended by the manufacturer or sold with the product. Any mounting of the product should follow the manufacturer's instructions and should use a mounting



PORTABLE CART WARNING  
(Symbol provided by RETAC)

accessory recommended by the manufacturer.

- 9** A product and cart combination should be moved with care. Quick stops, excessive force, and uneven surfaces may cause the product and cart combination to overturn.
- 10 Ventilation** - Slots and openings in the cabinet are provided for ventilation and to ensure reliable operation of the product and to protect it from overheating. These openings must not be blocked or covered. The openings should never be blocked by placing the product on a bed, sofa, rug, or other similar surface. This product should not be placed in a built-in installation such as a bookcase or rack unless proper ventilation is provided or the manufacturer's instructions have been adhered to.
- 11 Power Sources** - This product should be operated only from the type of power source indicated on the marking label. If you are not sure of the type of power supplied to your home, consult your product dealer or local power company. For products intended to operate from battery power, or other sources, refer to the operating instructions.
- 12 Grounding or Polarization** - This product may be equipped with a polarized alternating - current line plug (a plug having one blade wider than the other). This plug will fit into the power outlet only one way. This is a safety feature. If you are unable to insert the plug fully into the outlet, try reversing the plug. If the plug should still fail to fit, contact your electrician to replace your obsolete outlet. Do not defeat the safety purpose of the polarized plug.

## Important Safety Instructions (cont.)

- 13 Alternate Warnings** - This product is equipped with a three-wire grounding-type plug, a plug having a third (grounding) pin. This plug will only fit into the outlet, contact your electrician to replace your obsolete outlet. Do not defeat the safety purpose of the grounding-type plug.
- 14 Power-Cord Protection** - Power-supply cords should be routed so that they are not likely to be walked on or pinched by items placed upon or against them, paying particular attention to cords at plugs, convenience receptacles, and the point where they exit from the product.
- 15 Outdoor Antenna Grounding** - If an outside antenna or cable system is connected to the product, be sure the antenna or cable system is grounded so as to provide some protection against voltage surges and built-up static charges. Section 810 of the National Electrical Code, ANSI/NFPA 70 provides information with regard to proper grounding of the mast and supporting structure, grounding of the lead-in wire to an antenna discharge unit, size of grounding conductors, location of antenna-discharge unit, connection to grounding electrodes, and requirements for the grounding electrode.
- 
- 16 Lightning** - For added protection for this product during a lightning storm or when it is left unattended and unused for long periods of time, unplug it from the wall outlet and disconnect the antenna or cable system. This will prevent damage to the product due to lightning and power-line surges.
- 17 Power Lines** - An outside antenna system should not be located in the vicinity of overhead power lines or other electric light or power circuits, or where it can fall into such power lines or circuits. When installing an outside antenna system, extreme care should be taken to keep from touching such power lines or circuits as contact with them might be fatal.
- 18 Overloading** - Do not overload wall outlets, extension cords, or integral convenience receptacles as this can result in a risk of fire or electric shock.
- 19 Object and Liquid Entry** - Never push objects of any kind into this product through openings as they may touch dangerous voltage points or short-out parts that could result in a fire or electric shock. Never spill liquid of any kind on the product.
- 20 Servicing** - Do not attempt to service this product yourself as opening or removing covers may expose you to dangerous voltage or other hazards. Refer all servicing to qualified service personnel.
- 21 Damage Requiring Service** - Unplug this product from the wall outlet and refer servicing to qualified service personnel under the following conditions:
- When the power-supply cord or plug is damaged.
  - If liquid has been spilled or objects have fallen into the product.
  - If the product has been exposed to rain or water.
  - If the product does not operate normally by following the operating instructions. Adjust only those controls that are covered by the operating instructions as an improper adjustment of other controls may result in damage and will often require extensive work by a qualified technician to restore the product to its normal operation.
  - If the product has been dropped or damaged in any way.
  - When the product exhibits a distinct change in performance-this indicates a need for service.
- 22 Replacement Parts** - When replacement parts are required, be sure the service technician has used replacement parts specified by the manufacturer or that have the same characteristics as the original part. Unauthorized substitutions may result in fire, electric shock, or other hazards.
- 23 Safety Check** - Upon completion of any service or repairs to this product, ask the service technician to perform safety checks to determine that the product is in proper operating condition.
- 24 Heat** - The product should be situated away from heat sources such as radiators, heat registers, stoves, or other products (including amplifiers) that produce heat.
- 25 Wall or Ceiling Mounting** - The product should be mounted to a wall or ceiling only as recommended by the manufacturer.

# 1 - Welcome

## Unpacking

The following items are included with your DVD Recorder+VCR:

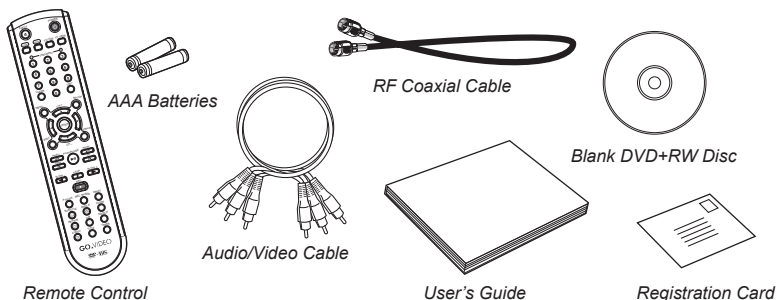

## Compatible Discs

The following disc types are compatible with your DVD Recorder+VCR:

### Playable Discs

- DVD Video
- DVD-R/RW (finalized) and DVD+R/RW
- Audio CD
- MP3 and JPEG files on CD-R/RW

### Recordable Discs

- DVD+R (Write-Once)
- DVD+RW (ReWritable)



Region 1 Discs Only

## What is YesDVD?

YesDVD™ enables you to create professional quality DVDs from your home recordings. Whenever you record or copy to DVD, YesDVD automatically:

- Analyzes your video, creating chapters at natural scene breaks
- Generates an interactive Disc Menu with thumbnails of each chapter for easy scene selection
- Produces three Music Videos using the best footage from your video, timed to the tempo of the music
- Allows you to print a full-color DVD case coversheet using images from your video.

Refer to page 22 to learn how to create a YesDVD.

*YesDVD is registered with the U.S. Patent and Trademark Office as a trademark of YesVideo, Inc. and is offered only for the personal, non-commercial use as characterized by the YesDVD Software Licensing Agreement.*

YESDVD™

## What is DoMiNoFX?

DoMiNoFX is a patented video processing technology that digitally enhances and refines the picture quality during copying and recording. This results in visibly superior recordings, and a dramatic improvement when recording from noisy source material, such as VHS tapes or weak TV signals.

DoMiNoFX  
VISIBLY SUPERIOR

# 1 - Welcome (cont.)

## Front Panel Overview

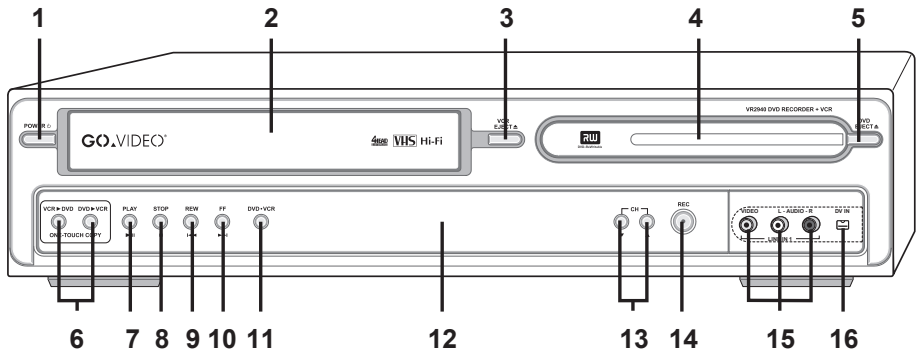

- 1 POWER**  
Turns the DVD Recorder+VCR on and off.  
Press and hold for five seconds to lock/unlock front panel keys.
- 2 VCR Deck**  
Insert your videotape here.
- 3 VCR EJECT ▲**  
Ejects the tape in the VCR deck.
- 4 Disc Tray**  
Insert your disc here.
- 5 DVD EJECT ▲**  
Opens and closes the disc tray.
- 6 ONE-TOUCH COPY**  
Copies from DVD to VCR or from VCR to DVD.
- 7 PLAY ►||**  
Starts/pauses playback.
- 8 STOP ■**  
Stops playback.
- 9 REW ◀◀**  
DVD: Skips to previous chapter/track.  
VCR: Rewinds the tape in Stop mode.  
Scans backward in Play mode.
- 10 FF ▶▶**  
DVD: Skips to next chapter/track.  
VCR: Fast-forwards the tape in Stop mode.  
Scans forward in Play mode.
- 11 DVD-VCR**  
Toggles control between the DVD and VCR decks.
- 12 Front Panel Display**  
Displays the status of the DVD Recorder+VCR.
- 13 CH ▲ / ▼**  
Selects the next/previous stored channel.
- 14 Record ●**  
Starts recording.
- 15 Line In 1**  
Connects to the audio/video output of an external source.
- 16 DV In**  
Connects to the DV output of a digital camcorder.

# 1 - Welcome (cont.)

## Front Panel Display Overview

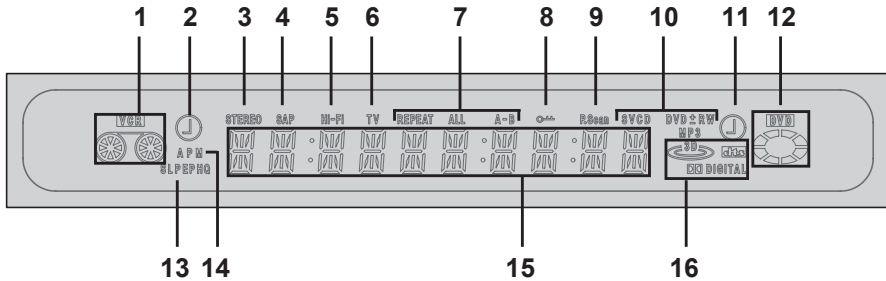

### When lit, indicates that:

- 1 A videotape is loaded in the VCR deck.
- 2 Circle: The VCR is recording.  
Clock: A VCR Timer Recording is set.
- 3 A stereo broadcast is being received.
- 4 A Second Audio Program (SAP) is being received.
- 5 A tape is playing or recording with Hi-Fi sound.
- 6 TV mode is enabled (as set by the TV/VCR button)
- 7 Repeat mode is active.
- 8 Parental Control is enabled.
- 9 The video signal is being output in Progressive Scan mode.
- 10 The indicated disc type is loaded.
- 11 Circle: The DVD deck is recording.  
Clock: A DVD Timer Recording is set
- 12 A disc is inserted in the DVD deck.
- 13 The indicated Recording Mode is active.
- 14 The time is currently AM or PM.
- 15 Displays the clock, total playing time, elapsed time, remaining time, title number, chapter/track number, channel, VCR counter, etc.
- 16 DTS: A DVD is playing with a DTS soundtrack.  
Dolby : A DVD is playing with a Dolby Digital soundtrack.



# 1 - Welcome (cont.)

## Remote Control Overview

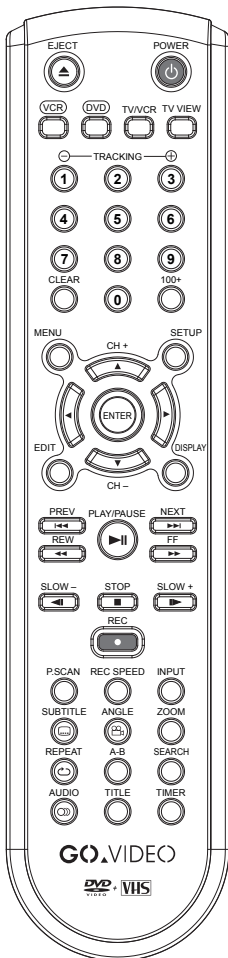

### Alphabetical listing of remote buttons and their functions:

#### 0-9

Selects TV channels. Also use to enter numbers in the on-screen menus.

#### 100+

Selects channels numbered 100 or higher; e.g., to select chapter 140, press 100+, 4, 0.

#### A-B

Repeats an audio or video segment between two points (A and B) during disc playback.

#### ANGLE

Shows the same scene from different angles during DVD playback (not available on all DVDs).

#### ARROW KEYS ▲▼▶◀

Navigates in the on-screen menus.

#### AUDIO

Selects among all available audio options, including tracks, formats, channels, etc.

#### CH ▲ / ▼

Selects the next/previous stored channel.

#### CLEAR

Resets the tape counter in VCR mode.

#### DISPLAY

Displays information about the current disc, tape, or TV channel.

#### DVD

Selects DVD mode.

#### EDIT

Edits chapters or splits titles on DVD+R/RW discs.

#### EJECT ▲

DVD: Opens and closes the disc tray.

VCR: Ejects the tape in the VCR deck.

#### ENTER

Confirms menu settings, passwords, etc.

#### FF ▶▶

Scans forward at 2x, 4x, 8x, 16x, and 32x normal speed.

#### INPUT

Switches the DVD Recorder+VCR input to Tuner, LINE1, LINE2, or DV.

#### MENU

Displays the DVD's Disc Menu (if applicable).

#### NEXT ▶▶

Skips to the next chapter or track during DVD playback.

#### P.SCAN

Press and hold for 3 seconds to switch between Progressive Scan and Interlaced Scan modes (only applicable when using the Component Video out connections to a Progressive Scan TV).

#### PLAY ▶▶

Starts playback. Pauses playback or recording. Press again to exit Pause mode.

#### POWER

Turns the DVD Recorder+VCR on and off.

# 1 - Welcome (cont.)

## Remote Control Overview (cont.)

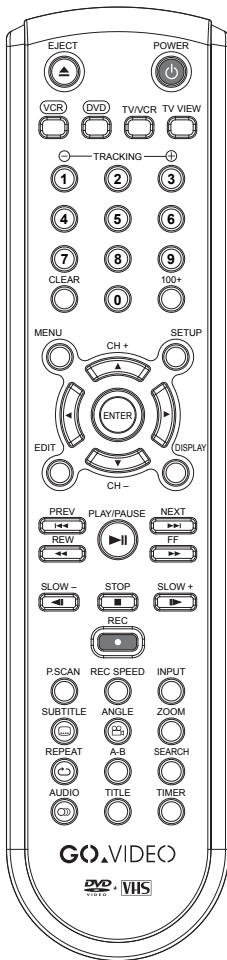

### PREV ◀◀

Skips to the previous chapter or track during DVD playback.

### REC ●

Starts recording.

### REC SPEED

DVD: Sets the recording mode to HQ (1 hr), SP (2 hrs), EP (4 hrs), or SLP (3 hrs).

VCR: Sets the recording mode to SP or SLP (3 times SP).

### REPEAT

Repeats the current title, chapter, track, or disc.

### REW ◀◀

Scans backward at 2x, 4x, 8x, 16x, and 32x normal speed.

### SEARCH

Jumps to a specific title, chapter, track, or time during disc playback.

### SETUP

Displays or exits the Setup menu.

### SLOW+/-

Plays at 1/2, 1/4, or 1/8 normal speed.

### STOP ■

Stops and holds playback or recording. Press again to reset playback to the beginning of the disc.

### SUBTITLE

Selects among all available subtitle languages during DVD playback.

### TIMER

Displays the Timer Recording menu.

### TITLE

Displays a disc's Title Menu (if available).

### TRACKING +/-

Manually adjusts tracking during VCR playback.

### TV VIEW

Switches the view on your TV to the DVD Recorder+VCR.

### TV/VCR

Switches between the DVD Recorder+VCR's tuner and your TV's tuner.

### VCR

Selects VCR mode.

### ZOOM

Magnifies the size of the on-screen image. Use the arrow keys to move around the magnified image.

# 1 - Welcome (cont.)

## Rear Panel Overview

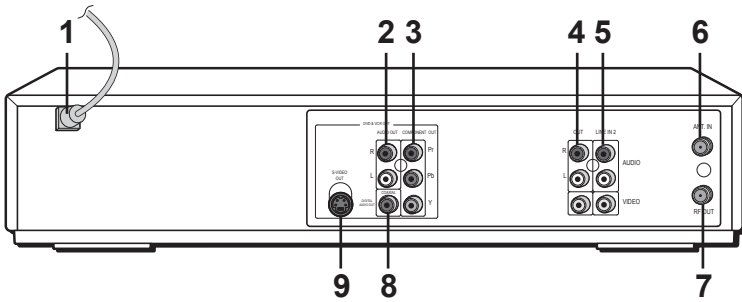

- 1 AC Power Cord**  
Connects to a power outlet.
- 2 Audio Output**  
Connects to a TV or stereo receiver with left/right audio inputs.
- 3 Component / Progressive Scan Video Output**  
Connects to a TV with Progressive Scan or Component Video inputs.
- 4 Audio/Video Output**  
Connects to a TV with audio/video inputs.
- 5 Line In 2**  
Connects to the audio/video outputs of an external source device (VCR, cable box, satellite receiver, etc.).
- 6 RF Input**  
Connects to your antenna or cable TV outlet.
- 7 RF Output**  
Connects to a TV with an RF coaxial input.
- 8 Coaxial (Digital Audio Output)**  
Connects to an amplifier/receiver with a coaxial digital audio input.
- 9 S-Video Output**  
Connects to a TV with an S-Video input.

## 2 - Connections/Setup

### Antenna/Cable Connections

#### Connecting an Antenna/Basic Cable

Connect the RF coaxial cable from your antenna or cable wall outlet to the ANT. IN jack as shown.

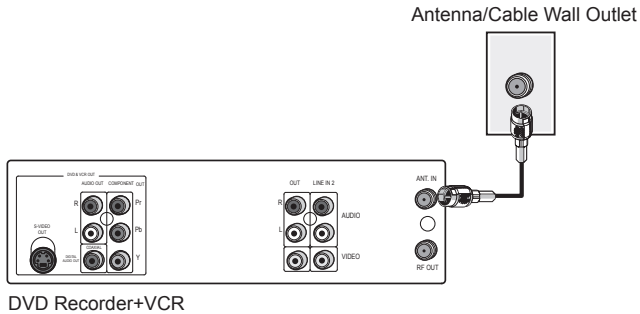

#### Connecting a Cable Box/Satellite Receiver

Connect the RF coaxial cable from your cable box/satellite receiver to the ANT. IN jack as shown.

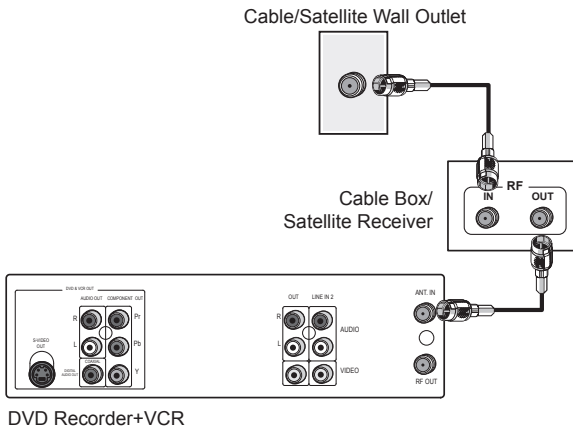

#### To view or record from the cable box/satellite receiver:

- Set your TV to the correct video input (channel 3 or 4 if using the RF connection).
- Set the DVD Recorder+VCR to the output channel of your cable box/satellite receiver using the CH ▲ / ▼ or 0-9 keys (e.g., channel 3).
- Select the desired channel on the cable box.

## 2 - Connections/Setup (cont.)

### Basic TV Connections

You can choose one of four ways to connect the DVD Recorder+VCR to your TV (in order of increasing picture quality): 1) RF, 2) Audio/Video, 3) S-Video, 4) Component Video/Progressive Scan. Choose only one of these connection methods.

#### RF Coaxial Connections

- 1 Connect the supplied RF coaxial cable from the RF OUT jack to the ANT. IN jack on your TV as shown.
- 2 Tune your TV to channel 3 or 4.
  - To change the RF out channel to 3 or 4, see Modulator Out on page 31.
- 3 Continue with Initial Setup on page 17.

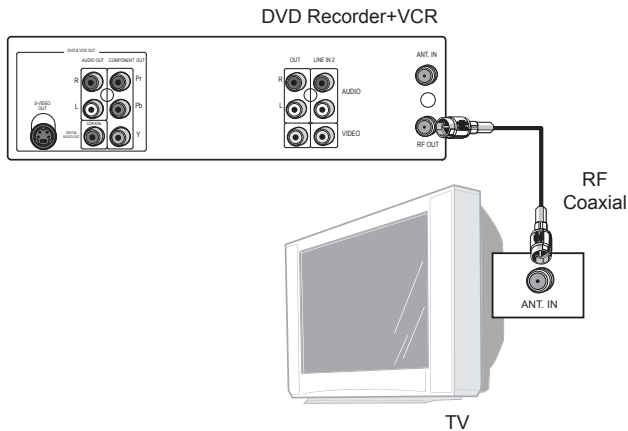

#### Standard Audio/Video Connections

- 1 Connect the supplied audio (red/white) and video (yellow) cable from the Audio/Video Out jacks to the Audio/Video Inputs on your TV as shown.
- 2 Tune your TV to its video input.
- 3 Continue with Initial Setup on page 17.

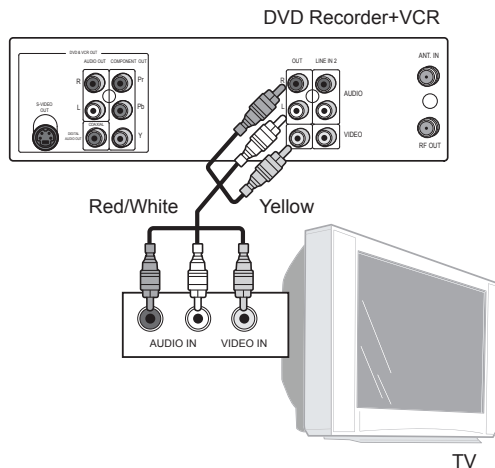

## 2 - Connections/Setup (cont.)

### Enhanced Video Connections

#### S-Video Connections

- 1 Connect an S-Video cable (not included) from the S-Video Out jack to the S-Video input on your TV as shown.
- 2 Set your TV to its S-Video input.
- 3 Choose one of the enhanced audio connections on page 15.

#### Component Video/Progressive Scan Connections

- 1 Connect a Component Video cable (not included) from the Component Out jacks (Y, Pb, Pr) to the Progressive Scan or Component Video inputs on your TV as shown.
- 2 Set Scan Mode to Interlace (for Component) or Progressive (for Progressive Scan) in the Setup menu.
  - You can also press and hold **P.SCAN** for 3 seconds as a shortcut to switch between Progressive and Interlace Scan.
- 3 Set your TV to its Progressive Scan or Component Video input.
- 4 Choose one of the enhanced audio connections on page 15.

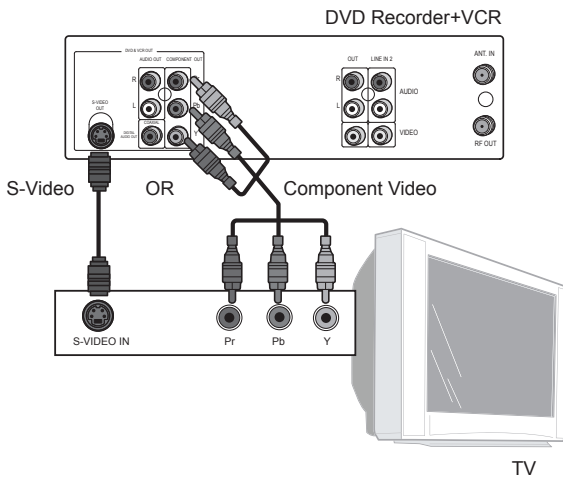

## 2 - Connections/Setup (cont.)

### Enhanced Audio Connections

For enhanced audio quality, you can connect the DVD Recorder+VCR to a stereo system or digital amplifier/receiver.

#### Stereo/Receiver Connections

- 1 Connect the supplied audio cable (red and white) from the Audio Out jacks to the Audio inputs on your stereo or 2-channel analog receiver as shown.
- 2 Set your stereo/receiver to its appropriate input to hear the DVD Recorder+VCR.
- 3 Continue with Initial Setup on page 17.

#### Digital Receiver Connections

- 1 Connect a digital coaxial cable (not included) from the Coaxial jack to the coaxial digital audio input on your digital receiver.
- 2 Set the Digital Output to Bitstream (Digital) or LPCM (Stereo) in the Setup menu, depending on the capabilities of your receiver.
- 3 Set your receiver to its appropriate input to hear the DVD Recorder+VCR.
- 4 Continue with Initial Setup on page 17.

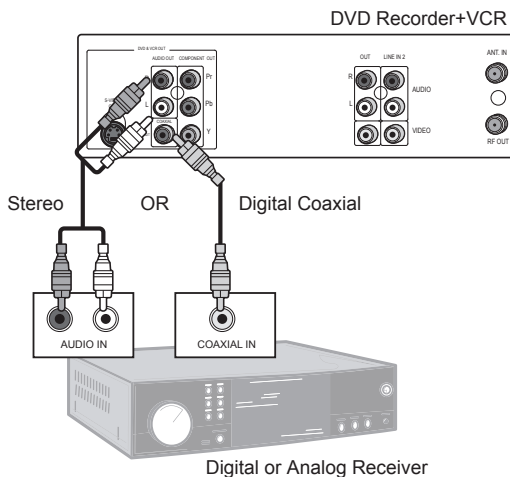

## 2 - Connections/Setup (cont.)

### Optional Equipment Connections

You can connect optional devices, such as a VCR, camcorder, or video game, to the Line 1 (front panel) or Line 2 (rear panel) audio/video jacks. You can also connect a MiniDV camcorder to the front DV IN jack.

#### External Device Connections

- 1 Connect an audio (red/white) and video (yellow) cable from the Audio/Video outputs on your device to the Audio/Video inputs on the DVD Recorder+VCR as shown.
- 2 Press INPUT repeatedly to view the Line 1 (front panel) or Line 2 (rear panel) input.

#### Digital Camcorder Connections

- 1 Connect a DV cable (not included) from the DV output on your device to the DV input on the front panel of the DVD Recorder+VCR as shown.
- 2 Press INPUT repeatedly to view the DV input.

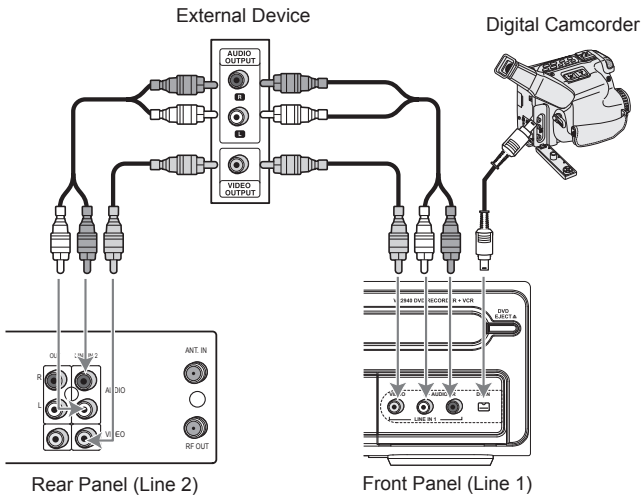



## 2 - Connections/Setup (cont.)

### Initial Setup

After successfully connecting your DVD Recorder+VCR to your TV and other devices, you are ready to complete the Initial Setup.

- 1 The Welcome screen is displayed. Press **ENTER** to continue.
- 2 Use **▲/▼** to select the desired language for the Initial Setup, then press **ENTER**.
- 3 Use **▲/▼** to select your preferred language for DVD Disc Menus, then press **ENTER**.
- 4 Use **▲/▼** to select your preferred language for DVD audio soundtracks, then press **ENTER**.
  - Choose "Default" to always select the disc's default audio language.
- 5 Use **▲/▼** to select your preferred language for DVD subtitles, then press **ENTER**.
  - Choose "Default" to always select the disc's default subtitle language.
  - Choose "Off" to always turn off subtitles.
- 6 Use **▲/▼** to select the type of signal you are using to watch TV, then press **ENTER**.
  - **CATV** - if using a Cable TV hookup
  - **Antenna** - if using an Antenna
  - **Detect Automatically** - if you are not sure
- 7 Wait for the DVD Recorder+VCR to search for available TV stations.
  - This may take a few minutes to complete.
- 8 Set the clock.
  - Use **◀/▶** to highlight each setting (hour, minute, etc.).
  - Use **▲/▼** to adjust each setting.
  - When finished, press **ENTER**.
- 9 An information screen appears introducing the YesDVD feature. Press **ENTER** to continue.
- 10 Initial Setup is complete!
  - The DVD Recorder+VCR tunes to the lowest channel found.

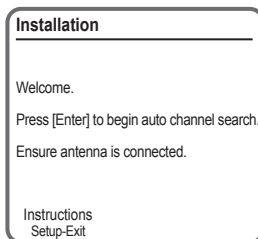

*Follow the Installation screens to set up your DVD Recorder+VCR*

## 3 - Playback

### Playing DVDs

#### Before you begin:

- Press the **DVD** button to set the remote control to operate the DVD deck.
- Turn the TV on and select the video input source connected to the DVD Recorder+VCR.
- Turn your audio system on and select the input source connected to the DVD Recorder+VCR.

- 1 Press **DVD EJECT** to open the disc tray.
- 2 Load your disc in the tray with the playback side down (label side up).

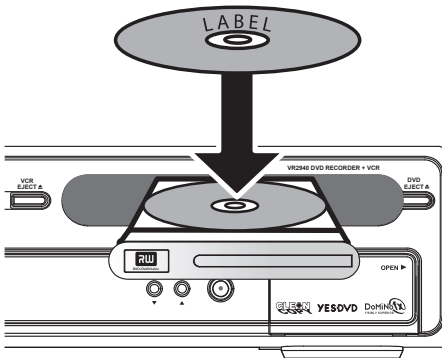

- 3 Press **DVD EJECT** to close the tray.
- 4 Playback starts automatically. If playback does not start, press **PLAY/PAUSE** ►||.
- 5 In some cases, the Disc Menu might appear. Use the ◀ ▶ ▲ ▼ buttons to select the title/chapter you want to view, then press **ENTER** to start playback.



**NOTE:** When you insert a DVD+RW or unfinalized DVD+R, the current TV channel displays on the screen. Press **MENU** to display the Disc Menu. Use the ◀ ▶ ▲ ▼ buttons to select the title you want to view, then press **ENTER**.

### Special DVD Playback Features

#### Still Picture and Frame-by-Frame Playback

- Press **PLAY/PAUSE** ►|| during playback. The DVD Recorder+VCR will go into Pause mode.
- While in Pause mode, press **FF** ►► repeatedly to advance the picture frame-by-frame.

#### Fast Forward/Backward

- Press **REW** ◀◀ or **FF** ►► during playback to scan backward or forward at variable speeds (X2, X4, X8, X16, X32).

#### Skip Previous/Next

- Press **PREV** ◀◀ or **NEXT** ►► during playback to select the next or previous chapter.

#### Slow Motion

- Press **SLOW+** during playback to play in slow motion at variable speeds (1/2, 1/4, 1/8).
- Pressing **SLOW-** changes the forward slow motion speed. There is no reverse slow motion.

#### Audio

- Press **AUDIO** repeatedly during playback to select among all available audio languages or audio tracks.

#### Subtitle

- Press **SUBTITLE** repeatedly during playback to select among all available subtitle languages.

#### Angle

- If a DVD contains scenes recorded at different angles, the angle icon displays on-screen.
- Press **ANGLE** repeatedly during playback to select the desired angle.

#### Zoom

- Press **ZOOM** repeatedly during playback to magnify the video image at variable sizes (x1, x2, x4).
- Use the arrow keys to scroll around the enlarged image.
- Zoom does not work in Pause mode.

## 3 - Playback (cont.)

### Disc Menus

Many DVDs have Disc Menus that allow you to access chapters and/or special features.

- Press **MENU** to open a Disc Menu.
- Use the **0-9** buttons to directly select the desired options, or use **◀ ▶ ▲ ▼** to highlight your desired selection and press **ENTER**.
- To exit the Disc Menu, press **STOP** or **TV VIEW**.

### Title Menus

Some DVDs have Title Menus that allow you to access titles and/or special features.

- Press **TITLE** to display the disc's Title Menu (if available). If there is no Title Menu, the Disc Menu may appear.

### Display

The On-Screen Display provides feedback on the status of the DVD Recorder+VCR and/or the currently loaded disc or tape.

- Press **DISPLAY** once to display information about the current disc.
- Use the **▲ ▼** keys to select Title, Chapter, Angle, Audio, Subtitle, or Elapsed, then press **ENTER**.
- Use the **▲ ▼** keys to select the desired option, then press **ENTER**.
- Press **DISPLAY** again to show the disc remaining time.
- Press **DISPLAY** again to remove the On-Screen Display.

### Repeat

- Press **REPEAT** to repeat the current chapter, title, disc.
- Continue pressing **REPEAT** to enter Shuffle mode (random playback of chapters/tracks) or Scan (plays the first few seconds of every chapter/track).

### A-B

You can repeat a scene between two points (A and B):

- 1 Press **A-B** to mark the start point.
- 2 Press **A-B** to mark the end point.
- 3 The marked scene is repeated continuously.
- 4 Press **A-B** again to cancel.

### Search

- 1 Press **SEARCH** to display the Search menu.
- 2 Use **◀ ▶** to move to T (Title) or C (Chapter).
- 3 Use **▲ ▼** to select the desired title or chapter number.

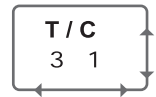

## 3 - Playback (cont.)

### Playing VHS Tapes

#### Before you begin:

- Press the **VCR** button to set the remote control to operate the VCR deck.
- Turn the TV on and select the video input source connected to the DVD Recorder+VCR.
- Turn your audio system on and select the input source connected to the DVD Recorder+VCR.

- 1 Insert a videotape in the VCR deck.
  - The DVD Recorder+VCR will power on automatically.
  - If a tape without a record safety tab is inserted, the DVD Recorder+VCR will start playback automatically.

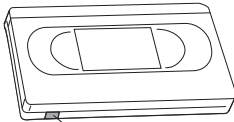

- 2 Press **PLAY/PAUSE** ►||.
- 3 Press **STOP** ■ to stop playback.
  - If the tape reaches the end before **STOP** ■ is pressed, the DVD Recorder+VCR will automatically stop, rewind, and eject the tape.

### Special VCR Playback Features

#### Auto Tracking

The automatic tracking function adjusts the picture to remove snow or streaks. It works in the following cases:

- When a tape is played for the first time.
- When the tape speed (SP, SLP) changes.
- When streaks or snow appear because of scratches on the tape.

#### Manual Tracking

If noise appears on the screen during playback, press the **TRACKING +/-** buttons on the remote control until the noise on the screen is reduced.

#### Visual Search Forward/Backward

- Press **REW** ◀◀ or **FF** ▶▶ during playback to scan forward and backward at variable speeds.

#### Still Picture

- Press **PLAY/PAUSE** ►|| during playback to pause the on-screen image.
- If the picture vibrates, stabilize it by using the **TRACKING +/-** buttons.

#### Slow Motion

- Press **SLOW+** for slow motion playback.
- Press **SLOW+** and **SLOW-** repeatedly to adjust the slow motion playback speed.

#### Counter Memory Function

- Press **CLEAR** to reset the real-time counter to 0:00:00.
- To automatically search for a specific tape counter position, use the Go-To Search function; see page 36.

## 3 - Playback (cont.)

### Playing Audio/MP3 CDs

You can play audio CDs and MP3 files on CD-R/RW.

- 1 Insert your CD and close the disc tray.
- 2 The disc loads and the Audio CD or MP3 CD menu appears.

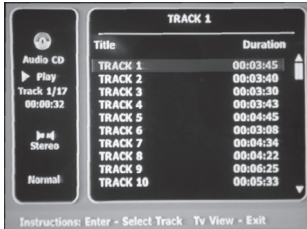

- 3 Use **▲ ▼** to select a track or a file, then press **PLAY/PAUSE ►||** or **ENTER** to start playback.

### Options During Audio Playback

- Press **FF** or **REW** for double-speed playback.
- Press **PLAY/PAUSE ►||** to pause playback.
- Press **STOP** to stop playback.
- Press **REPEAT** to repeat a track or a file. Press **REPEAT** again to repeat the entire disc.
- If the disc contains JPEG files as well as MP3 files, press **TITLE** to change the Play mode to display JPEG image files.

### Playing Picture CDs

You can display Kodak Picture CDs and JPEG files on CD-R/RW.

- 1 Insert your CD and close the disc tray.
- 2 The disc loads and the Kodak Picture CD or JPEG CD menu appears.

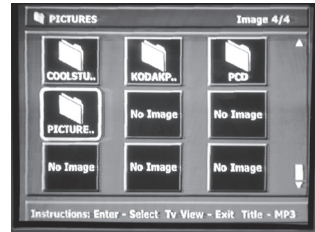

- 3 Use **◀ ▶ ▲ ▼** to select the desired folder or image thumbnail, then press **ENTER**.
- 4 The full size image is displayed and a slide show starts automatically with an interval of 10 seconds between pictures.

### Options During a Slideshow

- Press **NEXT ►►** or **PREV ◀◀** to manually skip to the next or previous image.
- Press **◀ ▶** to rotate the image in 90 degrees increments.
- Press **STOP ■** to exit the slideshow.
- If the disc contains MP3 files as well as MP3 files, press **TITLE** to change the Play mode to play MP3 files.

### Playing MP3 Files During a Slide Show

You can enjoy a slide show while listening to MP3 music files.

- 1 Prepare a CD which includes both MP3 and JPEG files.
- 2 Insert the CD and play an MP3 file.
- 3 Press **TITLE** while playing the MP3 file to change the Play mode. The music playback will not stop.
- 4 Select an image file and press **ENTER** to start the slide show.
- 5 The MP3 file you selected continues to play during the JPEG slide show.

## 4 - Recording

### About YesDVD™

YesDVD allows you to transfer your videotapes or other video content to a DVD+R/RW with the professional quality features found in Hollywood movies.

Whenever you record or copy to DVD, you can enable YesDVD to automatically:



- Analyze your video, creating chapters at natural scene breaks
- Generate an interactive Disc Menu with thumbnails of each chapter for easy scene selection
- Produce three Music Videos using the best footage from your video, timed to the tempo of the music
- Allow you to print a full-color DVD case coversheet using images from your video.

### YesDVD Requirements

- Creation of a YesDVD is only possible on the first recording from a blank DVD+R/RW disc.
- The recording can be made from the VCR deck or one of the external input sources (Line1, Line2, or DV).
- No further footage can be added to a YesDVD once recording is stopped (by selecting STOP ■).
- In order to print DVD case coversheets, you must have a Microsoft™ Windows™-based PC with a DVD-ROM drive and a printer.
- There is no limit to the number of YesDVD discs you can create with this DVD Recorder+VCR.
- To erase a finalized YesDVD on a DVD+RW disc, start a new recording and select "Yes" when prompted to erase the disc.
- The recommended minimum length of a YesDVD recording is 5 minutes. If the total recording time is less than 5 minutes, the three Music Videos will not be created.

### Creating a YesDVD

- 1 Enable YesDVD in the Setup menu; see page 32.
- 2 Set up any kind of recording (Basic, One Touch Recording, One Touch Copy, etc.).
  - For best results, make sure you set the Record Mode as closely as possible to the actual length of your recording; e.g, if you plan to record for 1 hour, use HQ mode. If you plan to record for 2 hours, use SP mode, etc.
- 3 Record your DVD+R/RW.
- 4 Stop recording.
  - Remember, once recording is stopped, no further content can be added to the YesDVD (even if you are using a DVD+RW disc).
  - At the end of your recording, a dialog box will appear asking if you want to create a YesDVD.
  - Press ▲ ▼ to select "Yes" in the menu and press **ENTER** to confirm.
- 5 The YesDVD is created.
  - This may take several minutes to complete; e.g., for a 2 hour recording, allow approximately 15 minutes to create your YesDVD.
  - A graphical display shows the progress of your YesDVD.
- 6 When finished, you will be prompted to eject the disc to print a DVD case coversheet. Press **ENTER** to continue.
  - The YesDVD disc menu appears.
  - Use the ◀ ▶ ▲ ▼ buttons and press **ENTER** to view the desired Chapter or Music Video.
- 7 Print a YesDVD case coversheet (optional).
  - Insert your finished YesDVD in a Windows-based PC with a DVD-ROM drive.
  - Follow the on-screen instructions to print the DVD case coversheet.
  - The 7" x 5" coversheet can be printed in color or black and white and includes thumbnail images from your video.
  - Cut out your case cover and insert it in a standard DVD case.

## 4 - Recording (cont.)

### Basic Recording

#### Recording from TV

Follow the instructions below to record a TV program.

- 1 Turn on the DVD Recorder+VCR and load a recordable disc or tape.

- Make sure your TV input is set to view the DVD Recorder+VCR.

- 2 Set the desired Recording mode by pressing REC SPEED repeatedly.

#### DVD Record Speeds:

- HQ - Best quality (1 hour/disc).
- SP - Good quality (2 hours/disc).
- EP - Average quality (4 hours/disc).
- SLP - Low quality (6 hours/disc).

#### VCR Record Speeds:

- SP - Good quality
- SLP - Low quality (3 times the recording length of SP mode).

- 3 Use CH ▲ ▼ to select the TV channel you wish to record.

- If your DVD Recorder+VCR does not show a TV program, press **TV VIEW** on the remote control.

- 4 Press **AUDIO** to select the audio channel to record (Stereo, SAP, or Mono).

- 5 Press **REC ●** once to start recording.

- If you are recording on a DVD+R or DVD+RW disc for the first time, it will be initialized to prepare for recording. This may take a few minutes to complete.
- To record for a fixed length of time, see One Touch Recording at right.

- 6 Press **STOP ■** to stop recording.

- The disc is updated with the new recording. This may take several minutes to complete.

- 7 (Optional) If YesDVD is enabled and this is your first recording on the disc, press ▲ ▼ to select:

- **Yes** - Create a YesDVD from your recording. The unit will make a YesDVD with a Disc Menu and three one-minute videos. You will not be able to add any more recordings to the disc. See page 22 for more details.

- **No** - Do not create a YesDVD. You can continue to make recordings on the disc, but you will no longer have the option of creating a YesDVD on this disc (unless the disc is a DVD+RW and you completely erase it; see page 27).

### Options During Recording

- To pause the disc or tape during recording, press **PLAY/PAUSE ►||**.
- To resume recording, press **PLAY/PAUSE ►||** or **REC ●**.
- To check the recording time (total and elapsed), press **DISPLAY** twice. The recorded time is also shown on the front panel display.

### Recording Tips

- Always use **PLAY/PAUSE ►||** for best results when making changes during recording. For example, to change channels during recording, first press **PLAY/PAUSE ►||** to put the unit in Pause mode. Then select the desired channel on the DVD Recorder+VCR, and press **PLAY/PAUSE ►||** again to resume recording.
- You cannot record on the VCR deck and DVD deck at the same time.
- While the VCR is recording, DVD playback is possible. However, while the DVD is recording, all VCR functions are disabled.

### One Touch Recording (OTR)

One Touch Recording allows you add recording time in fixed increments at the touch of a button.

- 1 Follow steps 1-4 under "Recording from TV."
- 2 Press **REC ●** repeatedly to add recording time in 15 minute increments (DVD, to a maximum of 360 minutes) or 30 minutes (VCR, to a maximum of 240 minutes) within the available space. The recording time is displayed on screen and on the front panel display.
- 3 To quit One Touch Recording, press and hold **STOP ■** for 3 seconds.
- 4 If YesDVD is enabled and this is your first recording on the disc, you will have the option of creating a YesDVD (see page 22 for more details).

## 4 - Recording (cont.)

### One Touch Copy

#### Copying from DVD to VHS

You can copy the contents of a DVD to a VHS tape using the front panel **DVD ▶ VCR** button.

- 1 Insert the disc you wish to copy in the DVD deck and close the disc tray.
- 2 Insert a blank VHS videotape into the VCR deck.
- 3 Select DVD mode by pressing **DVD** on the remote control or **DVD•VCR** on the front panel.
- 4 Find the place on the DVD from which you want to start recording using the **PLAY/PAUSE ▶||**, **REW◀◀** and **FF▶▶** functions.
  - For best results, pause playback at the point from which you want to record.
- 5 Press **DVD ▶ VCR** on the front panel.
  - The Copy to VCR menu appears.
- 6 Press **REC SPEED** to select the desired Record Mode:
  - SP - Good quality
  - SLP - Low quality (3 times the recording length of SP mode).
- 7 Press **DVD ▶ VCR** again to start copying.
- 8 To stop copying at any time, press **STOP■**.
  - You must stop the copy process manually when the DVD ends, or the unit may replay and record over and over again.



*NOTE: if the DVD you are attempting to copy is copy-protected, you will not be able to copy the disc. It is not permitted to copy Macrovision encoded DVDs.*

*Copy to VCR does not work in Progressive Scan Mode*

*During one touch copy you can reposition the DVD and/or change the Record Speed by pressing **PLAY/PAUSE ▶||**. When finished, press **DVD ▶ VCR** again to resume copying.*

#### Copying from VHS to DVD

You can copy the contents of a VHS tape to a DVD+R/RW using the front panel **VCR ▶ DVD** button. This allows you to archive your old VHS tapes to DVD.

- 1 Insert the VHS videotape you wish to copy into the VCR deck.
- 2 Insert a blank DVD+R or DVD+RW disc in the DVD deck and close the disc tray.
- 3 Select VCR mode by pressing **VCR** on the remote control or **DVD•VCR** on the front panel.
- 4 Find the place on the VHS tape from which you want to start recording using the **PLAY/PAUSE ▶||**, **REW◀◀** and **FF▶▶** functions.
  - For best results, pause playback at the point from which you want to record.
- 5 Press **VCR ▶ DVD** on the front panel.
  - The Copy to DVD menu appears.
  - If the YesDVD logo appears on this menu, a YesDVD will automatically be created when recording is complete. To enable/disable the YesDVD feature, see page 32.
- 6 Press **REC SPEED** to select the desired Record Mode:
  - HQ - Best quality (1 hour/disc).
  - SP - Good quality (2 hours/disc).
  - EP - Average quality (4 hours/disc).
  - SLP - Low quality (6 hours/disc).
- 7 Press **VCR ▶ DVD** again to start copying.
- 8 To stop copying at any time, press **STOP■**.
  - Copying will stop automatically when the VHS tape ends.



*NOTE: If the VHS videotape you are attempting to copy is copy-protected, you will not be able to copy the tape. It is not permitted to copy Macrovision encoded tapes.*

*During one touch copy you can reposition the tape by pressing **PLAY/PAUSE ▶||**. When finished, press **VCR ▶ DVD** again to resume copying.*



## 4 - Recording (cont.)

### Timer Recording

#### Setting a Timer Recording

You can set up to 8 programs to record within any one-month period.

- 1 Insert recordable media such as a DVD+R/ RW disc or a blank VHS tape.
- 2 Press **TIMER**.
  - The Timer Recording menu appears.

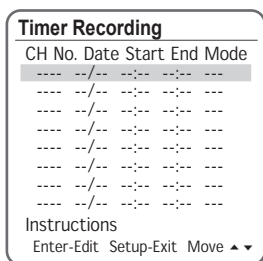

- 3 Use ▲ ▼ to move to a timer recording slot, and press **ENTER** to modify it.
  - If you did not set the clock on the DVD Recorder+VCR, you must do so before programming a timer recording.
- 4 Use the ◀ ▶ ▲ ▼ keys to set the following:
  - **Media** - Choose DVD or VHS.
  - **Ch.** - Choose the desired channel, or one of the external inputs from which to record.
  - **Date** - Choose a date up to one month in advance, or select a daily or weekly program.
  - **Start Time** - Set the recording start time.
  - **End Time** - Set the recording end time.
  - **Mode** - Choose a Record mode.  
DVD: HQ, SP, SLP or EP  
VCR: SP, SLP
- 5 When finished, press **ENTER** to save your settings.
  - The Timer Record List will appear.
- 6 Press **SETUP** to exit the Timer Record List.
- 7 The Timer indicator on the front panel display will light or blink.
- 8 Power Off the DVD Recorder+VCR to start the Timer Recording.

### Timer Recording Notes

- The Timer indicator lights on the front panel display when the DVD Recorder+VCR is ready for the Timer Recording and powered off.
- The disc and tape indicator blink under the following conditions:
  - The DVD Recorder+VCR is not powered off.
  - No recordable tape is inserted.
  - Tape and disc timer recordings are overlapped.
- The DVD Recorder+VCR will record the audio according to the current TV tuner setting (Stereo, Mono or SAP). Use the **AUDIO** button to set the audio before switching the DVD Recorder+VCR to Standby mode.
- The DVD Recorder+VCR will automatically power off when the Timer Recording ends.
- There is a short delay when a timer recording finishes to confirm the recorded program. If two timer recordings are set to record sequentially (one right after the other), the very beginning of the later program may not be recorded.

### Canceling a Timer Recording

You can clear a Timer Recording any time before the recording actually starts.

- Use ▲ ▼ to select the program you want to erase on the Timer Recorder List, then press **ENTER** to modify it.
- Use ▲ ▼ to select Delete then press **ENTER**.

### Stopping a Timer Recording in Progress

After a Timer Recording has started, you can still cancel the program by pressing and holding **STOP ■** for 3 seconds.

## 4 - Recording (cont.)

### Timer Recording Troubleshooting

Even if a Timer Recording is set, the DVD Recorder+VCR will not record if:

- No disc is loaded.
- A non-recordable disc is loaded.
- The disc is locked; see page 27.
- There are already 49 titles recorded on the disc.

You cannot enter a Timer Recording if:

- A recording is already in progress.
- The start time has already passed.
- Eight Timer Recordings have already been set.

If two or more Timer Recordings overlap:

- The earlier program takes priority.
- When the earlier program finishes, the later program starts.
- If two programs are set to start at exactly the same time, the program entered first takes priority.

Confirmation is not possible when:

- The disc is locked; see page 27.
- There are already 49 titles recorded on the disc.



*NOTE: If the disc is damaged, the recording may not complete successfully, even if the Check field shows "Rec. OK."*

### Recording Priority

- Timer Recordings and One Touch Recordings have the same priority but they have lower priority than manual recording. During manual recording, Timer Recordings and One Touch Recordings will be ignored.

### Recording from an External Input

You can record from an external component, such as an analog or digital camcorder or VCR, connected to any of the DVD Recorder+VCR's external inputs.

- 1 Make sure the component you want to record from is connected properly to the DVD Recorder+VCR; see page 16.
- 2 Press INPUT or CH ▲ ▼ to select the external input to record from.
  - Tuner - Built-in tuner
  - LINE1 - Audio/Video Input on front panel
  - LINE2 - Audio/Video Input on back panel
  - DV - DV input on front panel.
- 3 Load a recordable disc or tape.
- 4 Set the desired Recording mode by pressing [REC SPEED] repeatedly.

#### DVD Record Speeds:

- HQ - Best quality (1 hour/disc).
- SP - Good quality (2 hours/disc).
- EP - Average quality (4 hours/disc).
- SLP - Low quality (6 hours/disc).

#### VCR Record Speeds:

- SP - Good quality
- SLP - Low quality (3 times the recording length of SP mode).

- 5 Press **REC** ● once to start recording.
  - Recording continues until you press **STOP** ■ or the disc is full.
  - To record for a fixed length of time, see One Touch Record on page 23.
- 6 Press **STOP** ■ to stop recording.
- 7 (Optional) If YesDVD is enabled and this is your first recording on the disc, press ▲ ▼ to select:
  - **Yes** - Create a YesDVD from your recording. The unit will make a YesDVD with a Disc Menu and three one-minute videos. You will not be able to add any more recordings to the disc. See page 22 for more details.



*NOTE: If your source is copy-protected, you will not be able to record it using the DVD Recorder+VCR.*

## 5 - Editing

### Disc Menu Options

Once you've made some recordings, you can use the Disc Menu to make your DVD+R or DVD+RW disc compatible with other players. You can also access these special disc level features:

- DVD+R - Allows you to rename your disc or finalize it so it will be compatible with most other DVD players.
- DVD+RW - Allows you to rename, erase, lock, or unlock your disc. You can also make it compatible with most other DVD players.

### Viewing Disc Information (DVD+RW)

To view information about the status of your DVD+RW disc, including disc type, number of recordings, total titles, free space, etc.:

- 1 Press **MENU** to display the Disc Menu.
- 2 Press **▲** to move to the top menu.
- 3 Press **▶** to display the Disc Menu.
- 4 View your disc information.
- 5 Press **SETUP** to return to the top menu, or press **TV VIEW** to exit and return to TV.

### Erasing a Disc (DVD+RW)

To erase a DVD+RW disc (DVD+R discs cannot be erased):

- 1 Press **MENU** to display the Disc Menu.
- 2 Press **▲** to move to the top menu.
- 3 Press **▶** to display the Disc Menu.
- 4 Use **◀ ▶** to select "Erase the disc," then press **ENTER**.
- 5 Use **▲ ▼** to select "Yes" or "No" and press **ENTER**. If you select "Yes", all contents on the disc will be erased.

### Locking/Unlocking a Disc (DVD+RW)

To protect a DVD+RW from accidental recording, editing, or erasing, you can lock the disc. If you change your mind, you can unlock the disc (DVD+R discs cannot be locked or unlocked).

- 1 Press **MENU** to display the Disc Menu.
- 2 Press **▲** to move to the top menu.
- 3 Press **▶** to display the Disc Menu.
- 4 Use **◀ ▶** to select "Lock/Unlock Disc," then press **ENTER**.
- 5 Use **▲ ▼** to select "Yes" or "No" and press **ENTER** to confirm.
- 6 The status of the disc will be changed to locked or unlocked. This may take a few moments to complete.

### Finalizing/Making a Disc Compatible

In order to play your recorded discs on other DVD players, they must be "Finalized" (DVD+R) or "Made Compatible" (DVD+RW).

- Finalizing a DVD+R locks its recordings in place so the disc can be played on most standard DVD players or computers equipped with DVD-ROM drives.
- Making a DVD+RW compatible automatically creates a menu screen for navigating the disc. This menu screen is accessible by pressing **MENU** or **TITLE**.

- 1 Press **MENU** to display the Disc Menu.
- 2 Press **▲** to move to the top menu.
- 3 Press **▶** to display the Disc Menu.
- 4 Use **◀ ▶** to select the "Finalize" (DVD+R) or "Make Compatible" (DVD+RW), then press **ENTER**.
- 5 Use **▲ ▼** to select "Yes" or "No" and press **ENTER**. If you select "Yes", the disc will be finalized/made compatible.
- 6 Press **SETUP** to return to the top menu, or press **TV VIEW** to exit and return to TV.



*NOTE: Once you have finalized a DVD+R disc, you cannot edit or record anything else on that disc.*

*The finalization process can take up to 3-4 minutes depending on the type of disc, how much is recorded on the disc, and the number of titles on the disc.*

*If you do not make your DVD+RW disc compatible, your edits will not be recognized by other DVD players.*

### Changing the Disc Name

To rename your disc to any name you choose:

- 1 Press **MENU** to display the Disc Menu.
- 2 Press **▲** to move to the top menu.
- 3 Press **▶** to display the Disc Menu.
- 4 Use **◀ ▶** to select "Change Disc Name," then press **ENTER**. The Keyboard Menu appears.
- 5 Use **◀ ▶ ▲ ▼** and press **ENTER** to select each character, or choose from these special functions:
  - CLR** - Clears the entire disc name.
  - SP** - Inserts a space.
  - DEL** - Deletes the last character.
- 6 Select "SAVE" and press **ENTER** to save your new disc name.

## 5 - Editing (cont.)

### Title Menu Options

The Title Menu provides options to play, erase, name, and overwrite your recorded titles (erase and overwrite features are for DVD+RW discs only).

#### Playing a Title

To play a title:

- 1 Press **MENU** to display the Disc Menu.
- 2 Use **▲ ▼** to select the desired title.
- 3 Press **▶** to display the Title Menu.
- 4 Use **◀ ▶** to select "Play Title," then press **ENTER**.
- 5 The DVD Recorder+VCR plays the selected title.

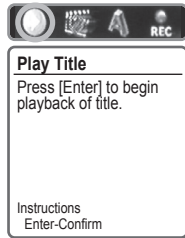

#### Erasing a Title (DVD+RW)

To erase a title on a DVD+RW disc (DVD+R titles cannot be erased):

- 1 Press **MENU** to display the Disc Menu.
- 2 Use **▲ ▼** to select the desired title.
- 3 Press **▶** to display the Title Menu.
- 4 Use **◀ ▶** to select "Erase Title," then press **ENTER**.
- 5 Use **▲ ▼** to select "Yes" or "No" and press **ENTER**. If you select "Yes", the title will be erased. This may take a few moments to complete.

#### Changing a Title Name

To rename a title:

- 1 Press **MENU** to display the Disc Menu.
- 2 Use **▲ ▼** to select the desired title.
- 3 Press **▶** to display the Title Menu.
- 4 Use **◀ ▶** to select "Change Name," then press **ENTER**. The Keyboard Menu appears.
- 5 Use **◀ ▶ ▲ ▼** and press **ENTER** to select each character, or choose from these special functions:
  - CLR** - Clears the entire disc name.
  - SP** - Inserts a space.
  - DEL** - Deletes the last character.
- 6 Select "SAVE" and press **ENTER** to save your new title name.

### Setting Title Record Options

To set DVD+R and DVD+RW record options, including overwriting of existing titles:

- 1 Press **MENU** to display the Disc Menu.
- 2 Use **▲ ▼** to select the desired title.
- 3 Press **▶** to display the Title Menu.
- 4 Use **◀ ▶** to select "Record Options," then press **ENTER**.
- 5 Select your preferred record options for each disc type (DVD+R and DVD+RW):

#### DVD+R

- **Make new recording appended to last** - Immediately begins recording by adding to the end of the currently selected title and continues recording until the end of the disc is reached (or until you press **STOP ■**).
- **Make new recording as new title** - Immediately starts recording a new title, and continues recording until the end of the disc is reached (or until you press **STOP ■**).

#### DVD+RW

- **Overwrite then stop** - Immediately begins recording over the currently selected title and stops when the end of the title is reached.
- **Overwrite and continue** - Immediately begins recording over the currently selected title and continues recording until the end of the disc is reached (or until you press **STOP ■**).
- **Append to existing** - Immediately begins recording by adding to the end of the currently selected title and continues recording until the end of the disc is reached (or until you press **STOP ■**).
- **Record new title to the end of the disc** - Immediately starts recording a new title, and continues recording until the end of the disc is reached (or until you press **STOP ■**).

## 5 - Editing (cont.)

### DVD Edit Menu Options

The DVD Edit Menu provides options to add, delete, hide and unhide chapters on your recorded discs. You can also change the thumbnail image that represents the title in the Disc Menu. You can even split a title on a DVD-RW disc.

#### Selecting a Title/Chapter to Edit

To select the title/chapter you wish to edit:

- 1 Press **MENU** to display the Disc Menu.
- 2 Use **▲ ▼** to select the desired title and press **EDIT** (not **ENTER**). The DVD Edit Menu is displayed and the selected title begins playing automatically.
- 3 Use **▲ ▼** to select "Title" or "Chapter," then press **ENTER**.
- 4 Use **▲ ▼** to select the title or chapter number you wish to edit, then press **ENTER**.
  - If the selected title has multiple chapters, you can also skip to the next or previous chapter by pressing **NEXT▶▶** or **PREV◀◀**.
  - If the DVD Edit Menu times out, you can press **DISPLAY** to bring it up again.

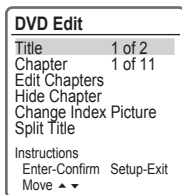

### Hiding/Unhiding Chapters

You can hide or unhide chapters on your DVD recordings. After hiding a chapter, the chapter is not deleted but only hidden during playback. This is useful for hiding commercials during playback of your TV recordings.

- 1 Press **MENU** to display the Disc Menu.
- 2 Use **▲ ▼** to select the desired title and press **EDIT** (not **ENTER**). The DVD Edit Menu is displayed.
- 3 Select the desired title and chapter as described at left.
- 4 Use **▲ ▼** to select "Hide Chapter" or "Unhide Chapter" then press **ENTER**.

### Changing Index Pictures

Each title in the Disc Menu is represented by a thumbnail picture taken from the start of that title or chapter. If you prefer, you can select a different still picture from within the title.

- 1 Press **MENU** to display the Disc Menu.
- 2 Use **▲ ▼** to select the desired title and press **EDIT** (not **ENTER**). The DVD Edit Menu is displayed.
- 3 Select the desired title and chapter as described at left.
- 4 Use **▲ ▼** to select "Change Index Picture" then press **ENTER**.
- 5 Use **▲ ▼** to select "Yes" (or "No").
- 6 Press **ENTER** when the preferred picture is on your TV screen. The new picture appears in the Disc Menu.

### Adding/Deleting Chapters

You can manually add or delete chapter markers in your titles during playback. Once a chapter is marked, you can use the chapter search feature as described above. You can also hide or unhide chapters as described at right.

- 1 Press **MENU** to display the Disc Menu.
- 2 Use **▲ ▼** to select the desired title and press **EDIT** (not **ENTER**). The DVD Edit Menu is displayed.
- 3 Use **▲ ▼** to select "Edit Chapters" then press **ENTER**.
- 4 Use **▲ ▼** to select one of the following options then press **ENTER**.
  - **Add** - Inserts a chapter marker at the current position.
  - **Delete** - Deletes the currently selected chapter marker.
  - **Delete All** - Deletes all chapter markers.
- 5 After editing is complete, a DVD+RW disc will not be compatible with other DVD players until you make the disc compatible; see page 27.

### Splitting a Title (DVD+RW)

This feature allows you to split one title into two.

- 1 Press **MENU** to display the Disc Menu.
- 2 Use **▲ ▼** to select the desired title and press **EDIT** (not **ENTER**). The DVD Edit Menu is displayed.
- 3 Select the desired title and chapter as described at left.
- 4 Use **▲ ▼** to select "Split Title" then press **ENTER**.
- 5 Use **▲ ▼** to select "Yes" (or "No") and press **ENTER** to split the title at the current position. This may take a few minutes to complete.

## 6 - Advanced Settings

### Setup Menu Overview

The Setup menu allows you to customize your DVD Recorder+VCR. Choose from six categories:

- Installation
- Recording Options
- Languages
- Preferences
- System Info
- Restore Defaults

### About Menu Navigation

- Press **SETUP** to display and exit the Setup menu.
- Use the **▲/▼** keys to move up and down.
- Use the **◀/▶** keys to move left and right.
- Use the **ENTER** key to make selections.

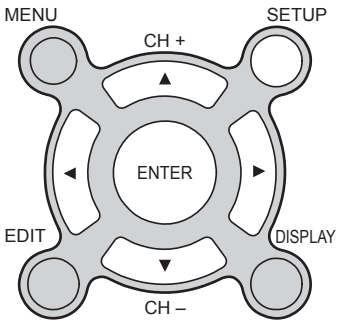

### Installation Settings

The Installation menu allows you to adjust all channel and clock settings.



### TV/CATV

Specifies whether you are using an antenna or cable TV to receive channels.



*If you receive channels from a cable box or satellite receiver connected to the Line Inputs, you do not need to adjust this setting.*

- 1 Press **SETUP**.
- 2 Use **◀/▶** to select "Installation."
- 3 Use **▲/▼** to select "TV/CATV," then press **ENTER**.
- 4 Use **▲/▼** to select the desired signal type, then press **ENTER**.
  - **TV** - If you are using an Antenna.
  - **CATV** - If you are using a Cable TV hookup.
- 5 Press **SETUP** to exit.

### Auto Channel Search

Searches for all available TV stations in the selected tuner band.

- 1 Press **SETUP**.
- 2 Use **◀/▶** to select "Installation."
- 3 Use **▲/▼** to select "Auto Channel Search," then press **ENTER**.
  - The unit searches for all available stations.
  - When finished, the unit displays the lowest channel found.

## 6 - Advanced Settings (cont.)

### Add/Remove Channels

Allows you to manually add or remove channels.

- 1 Press **SETUP**.
- 2 Use ◀ / ▶ to select "Installation."
- 3 Use ▲ / ▼ to select "Add/Remove Channels," then press **ENTER**.
- 4 Use ▲ / ▼ to select the desired channel.
- 5 Press **ENTER** to switch the channel's status to:
  - ✓ - Adds the selected channel.
  - x - Removes the selected channel.
- 6 Repeat steps 4-5 to continue adding/removing channels.
- 7 Press **SETUP** to exit.

### Modulator Out

Sets the channel you will use on your TV to view the DVD Recorder+VCR.

- This setting is only applicable when the unit is connected to a TV using the RF Out jack.
- 1 Press **SETUP**.
  - 2 Use ◀ / ▶ to select "Installation."
  - 3 Use ▲ / ▼ to select "Modulator Out," then press **ENTER**.
  - 4 Use ▲ / ▼ to select CH3 or CH4 then press **ENTER**.
  - 5 Tune your TV to this station to view the DVD Recorder+VCR.
  - 6 Press **SETUP** to exit.

### Set Clock

Sets the clock on the DVD Recorder+VCR. This is important when setting timer recordings.

- 1 Press **SETUP**.
- 2 Use ◀ / ▶ to select "Installation."
- 3 Use ▲ / ▼ to select "Set Clock," then press **ENTER**.
- 3 Use ◀ / ▶ to highlight and ▲ / ▼ to adjust each setting (hour, minute, etc.)
- 4 When finished, press **ENTER**.
- 5 Press **SETUP** to exit.

### Recording Settings

The Recording Options menu allows you to set the default quality for DVD and VCR recording. It also allows you to enable automatic chapter marking and the YesDVD feature as default settings.

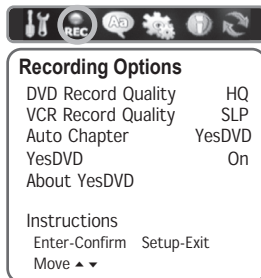

### DVD Record Quality

Sets the default DVD recording quality from 1-6 hours per disc. The higher the quality, the shorter the available recording time per disc.

- 1 Press **SETUP**.
- 2 Use ◀ / ▶ to select "Recording Options."
- 3 Use ▲ / ▼ to select "DVD Record Quality," then press **ENTER**.
- 4 Use ▲ / ▼ to select the desired record quality, then press **ENTER**.
  - **HQ** - Best quality (1 hour/disc).
  - **SP** - Good quality (2 hours/disc).
  - **EP** - Average quality (4 hours/disc).
  - **SLP** - Low quality (6 hours/disc).
- 5 Press **SETUP** to exit.

### VCR Record Quality

Sets the default VCR recording quality.

- 1 Press **SETUP**.
- 2 Use ◀ / ▶ to select "Recording Options."
- 3 Use ▲ / ▼ to select "VCR Record Quality," then press **ENTER**.
- 4 Use ▲ / ▼ to select the desired record quality, then press **ENTER**.
  - **SP** - Good quality
  - **SLP** - Low quality (3 times the recording length of SP mode).
- 5 Press **SETUP** to exit.

## 6 - Advanced Settings (cont.)

### Auto Chapter

Enables automatic chapter marking at regular intervals during DVD recording. Also provides an opportunity to enable the YesDVD feature.

- 1 Press **SETUP**.
- 2 Use ◀ / ▶ to select "Recording Options."
- 3 Use ▲ / ▼ to select "Auto Chapter," then press **ENTER**.
- 4 Use ▲ / ▼ to select the desired Auto Chapter setting, then press **ENTER**.
  - **Off** - Chapters will not be marked.
  - **5min, 10min, 15min** - Chapters will be created every 5, 10, or 15 minutes, respectively, during recording.
  - **YesDVD** - YesDVD will be enabled (see below).
- 5 Press **SETUP** to exit.

### YesDVD

YesDVD uses a patented technique to mark chapters at natural scene breaks within the source footage that you are recording. When the recording is complete, a YesDVD will be created, complete with a Disc Menu, three music videos, and an option to print a professional looking DVD case cover (using a Windows-based PC with a DVD-ROM drive and a printer).

YESDVD™

- 1 Press **SETUP**.
- 2 Use ◀ / ▶ to select "Recording Options."
- 3 Use ▲ / ▼ to select "Create YesDVD," then press **ENTER**.
- 4 Use ▲ / ▼ to turn the YesDVD option on or off, then press **ENTER**.
  - With YesDVD enabled, whenever you record to DVD+R/RW, chapters will be created automatically during scene changes. When you stop recording, a YesDVD will be created. See page 22 for details.
  - You can also select "About YesDVD" to view an informational screen describing the basic features of YesDVD.
- 5 Press **SETUP** to exit.

### Language Settings

The Languages menu allows you to set the default languages for on-screen displays, Disc Menus, subtitles, and audio soundtracks.

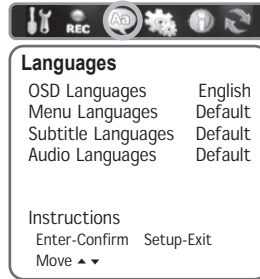

### OSD Language

Sets the default language for the DVD Recorder+VCR Setup menu and on-screen displays.

- 1 Press **SETUP**.
- 2 Use ◀ / ▶ to select "Languages."
- 3 Use ▲ / ▼ to select "OSD Language," then press **ENTER**.
- 4 Use ▲ / ▼ to select the desired OSD language (English, Spanish, or French), then press **ENTER**.
- 5 Press **SETUP** to exit.

### Menu Language

Sets your preferred language for DVD Disc Menus (if available).

- 1 Press **SETUP**.
- 2 Use ◀ / ▶ to select "Languages."
- 3 Use ▲ / ▼ to select "Menu Language," then press **ENTER**.
- 4 Use ▲ / ▼ to select your preferred Disc Menu language, then press **ENTER**.
  - Choose "Default" to always select the disc's default menu language.
- 5 Press **SETUP** to exit.



## 6 - Advanced Settings (cont.)

### Subtitle Language

Sets your preferred language for DVD subtitles (if available).

- 1 Press **SETUP**.
- 2 Use ◀ / ▶ to select "Languages."
- 3 Use ▲ / ▼ to select "Subtitle Language," then press **ENTER**.
- 4 Use ▲ / ▼ to select your preferred subtitle language, then press **ENTER**.
  - Choose "Default" to always select the disc's default subtitle language.
  - Choose "Off" to always turn off subtitles.
- 5 Press **SETUP** to exit.

### Audio Language

Sets your preferred language for DVD audio soundtracks (if available).

- 1 Press **SETUP**.
- 2 Use ◀ / ▶ to select "Languages."
- 3 Use ▲ / ▼ to select "Audio Language," then press **ENTER**.
- 4 Use ▲ / ▼ to select your preferred audio language, then press **ENTER**.
  - Choose "Default" to always select the disc's default audio language.
- 5 Press **SETUP** to exit.

### Preferences

The Preferences menu allows you to set a variety of user preferences for the DVD Recorder+VCR, including Video, Audio, Parental Control, AutoPlay, Auto Clock, and VCR search settings.

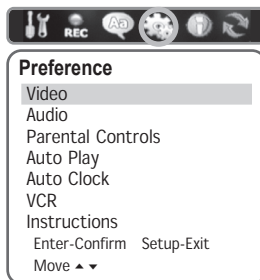

### Video Settings

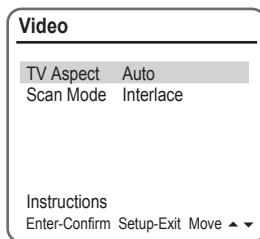

### TV Aspect

Sets your preferred aspect ratio for DVD movies.

- 1 Press **SETUP**.
- 2 Use ◀ / ▶ to select "Preferences."
- 3 Use ▲ / ▼ to select "Video," then press **ENTER**.
- 4 Use ▲ / ▼ to select "TV Aspect," then press **ENTER**.
- 5 Use ▲ / ▼ to select your preferred screen aspect ratio, then press **ENTER**.
  - **4:3 LB** (Letterbox) - Shows the full width of widescreen movies on a standard television with black bars above and below the picture.
  - **4:3 PS** (Pan & Scan) - Crops widescreen movies to fit a standard television.
  - **16:9** - Select if you have a widescreen television.
  - **Auto** - Selects the appropriate aspect ratio automatically.
- 6 Press **SETUP** to exit.

## 6 - Advanced Settings (cont.)

### Scan Mode

Enables or disables Progressive Scan.

- Do NOT enable Progressive Scan unless you have connected the DVD Recorder+VCR to a TV equipped with Progressive Scan inputs.
  - If you do accidentally select Progressive Scan and your screen goes black, press and hold the P.SCAN button on the remote control for 3 seconds to resume normal operation.
- 1 Press **SETUP**.
  - 2 Use ◀ / ▶ to select "Preferences."
  - 3 Use ▲ / ▼ to select "Video," then press **ENTER**.
  - 4 Use ▲ / ▼ to select "Scan Mode," then press **ENTER**.
  - 5 Use ▲ / ▼ to select your preferred Scan Mode, then press **ENTER**.
    - **Interlace** - Choose when using a standard video, S-Video, or Component video connection to your TV.
    - **Progressive** - Choose when using a Progressive Scan connection to your TV.
  - 6 Press **SETUP** to exit.

- **Bitstream** - Select if the DVD Recorder+VCR is connected to a 5.1 channel amplifier/receiver with a Dolby Digital decoder.
  - **LPCM** - Select if the DVD Recorder+VCR is connected to a 2 channel digital amplifier.
- 6 Press **SETUP** to exit.

### Dynamic Range

Compresses the dynamic range of the audio output (the difference between the loudest and quietest passages) while watching DVD movies. This allows you to listen to a movie at a lower volume without losing sound clarity.

- 1 Press **SETUP**.
- 2 Use ◀ / ▶ to select "Preferences."
- 3 Use ▲ / ▼ to select "Audio," then press **ENTER**.
- 4 Use ▲ / ▼ to select "Dynamic Range," then press **ENTER**.
- 5 Use ▲ / ▼ to set the Dynamic Range to Off, Low (minimal compression), or High (maximum compression), then press **ENTER**.
- 6 Press **SETUP** to exit.

### Audio Settings

Audio	
Digital Output	Off
Dynamic Range	Off
Virtual Surround	Off
VCR Reception	Stereo
Tape Play Back	Hi-Fi
Instructions	
Enter-Confirm Setup-Exit Movef	

### Digital Output

Sets the format of the signal from the Coaxial Digital Audio Out jack. This jack is used to output the audio signal recorded on DVD discs to an external digital amplifier/receiver.

- 1 Press **SETUP**.
- 2 Use ◀ / ▶ to select "Preferences."
- 3 Use ▲ / ▼ to select "Audio," then press **ENTER**.
- 4 Use ▲ / ▼ to select "Digital Output," then press **ENTER**.
- 5 Use ▲ / ▼ to select your preferred digital audio output signal, then press **ENTER**.
  - **Off** - Select if you are not using the digital audio output.

### Virtual Surround

Creates a simulated 3D effect from two speakers.

- 1 Press **SETUP**.
- 2 Use ◀ / ▶ to select "Preferences."
- 3 Use ▲ / ▼ to select "Audio," then press **ENTER**.
- 4 Use ▲ / ▼ to select "Virtual Surround," then press **ENTER**.
- 5 Use ▲ / ▼ to turn Virtual Surround on or off, then press **ENTER**.
- 6 Press **SETUP** to exit.

## 6 - Advanced Settings (cont.)

### VCR Reception

Sets your desired audio signal when recording a TV show to the VCR deck.

- 1 Press **SETUP**.
- 2 Use ◀ / ▶ to select "Preferences."
- 3 Use ▲ / ▼ to select "Audio," then press **ENTER**.
- 4 Use ▲ / ▼ to select "VCR Reception," then press **ENTER**.
- 5 Use ▲ / ▼ to select your preferred audio source for VCR recording, then press **ENTER**.
  - **Stereo** - Records the stereo signal.
  - **Mono** - Records the mono signal.
  - **SAP** - Records the Second Audio Program (often a second language).
- 6 Press **SETUP** to exit.

### Tape Playback

Sets your desired audio signal for VHS tape playback.

- 1 Press **SETUP**.
- 2 Use ◀ / ▶ to select "Preferences."
- 3 Use ▲ / ▼ to select "Audio," then press **ENTER**.
- 4 Use ▲ / ▼ to select "Tape Playback," then press **ENTER**.
- 5 Use ▲ / ▼ to select your preferred audio track for VHS playback, then press **ENTER**.
  - **Hi-Fi** - Plays the Hi-Fi track.
  - **Linear** - Plays the mono track.
  - **Mix** - Plays both the Hi-Fi and the Linear tracks.
- 6 Press **SETUP** to exit.

### Parental Controls

The Parental Controls feature allows you to block playback of DVDs based on their ratings.

#### Set Parental Level

Changes the Parental Control level.

- 1 Press **SETUP**.
- 2 Use ◀ / ▶ to select "Preferences."
- 3 Use ▲ / ▼ to select "Parental Controls," then press **ENTER**.
- 4 Use ▲ / ▼ to select "Set Parental Level," then press **ENTER**.

Change Password	
Current Code	█ _ _ _
Enter New Code	_ _ _ _
Confirm Code	_ _ _ _
Instructions	
Setup-Exit	

- 5 Use the 0-9 keys to enter your 4-digit password, then press **ENTER**.
  - If this is the first time you have entered a password, you will be prompted to enter the "Current Code" before you can enter your own code. You **MUST** enter 0-0-0-0 before you can set your own code.
  - If you enter the incorrect password, you will not be able to set the Parental Level.
- 6 Use ▲ / ▼ to select the desired Parental Level (1-8 or Off), then press **ENTER**.
  - Level 1 is the most restrictive, Level 8 is the least restrictive. Off allows all discs to play in full.
  - Not all discs are rated.
- 7 Press **SETUP** to exit.

#### Change Password

Changes the Parental Control password.

- 1 Press **SETUP**.
- 2 Use ◀ / ▶ to select "Preferences."
- 3 Use ▲ / ▼ to select "Parental Controls," then press **ENTER**.
- 4 Use ▲ / ▼ to select "Change Password," then press **ENTER**.
- 5 Use the 0-9 keys to enter your current password.
- 6 Use the 0-9 keys to enter your new password.
- 7 Use the 0-9 keys to re-enter your new password, and then press **ENTER**.
- 8 Press **SETUP** to exit.

## 6 - Advanced Settings (cont.)

### AutoPlay

Enables you to skip the ads and trailers and play your DVDs automatically when they are inserted in the tray.

- 1 Press **SETUP**.
- 2 Use **◀ / ▶** to select "Preferences."
- 3 Use **▲ / ▼** to select "AutoPlay," then press **ENTER**.
- 4 Use **▲ / ▼** to turn AutoPlay on or off.
- 5 Press **SETUP** to exit.

### Auto Clock

Enables the DVD Recorder+VCR to set the clock automatically whenever it is plugged in but powered off.

- 1 Press **SETUP**.
- 2 Use **◀ / ▶** to select "Preferences."
- 3 Use **▲ / ▼** to select "Auto Clock," then press **ENTER**.
- 4 Use **▲ / ▼** to turn Auto Clock on or off.
- 5 Press **SETUP** to exit.

### VCR Search

Enables you to search for index marks or tape counter positions on your videotapes.

- You must have a tape loaded for these features to be enabled.

#### Index Search

Searches for specific index marks on your videotape.

- 1 Press **SETUP**.
- 2 Use **◀ / ▶** to select "Preferences."
- 3 Use **▲ / ▼** to select "VCR," then press **ENTER**.

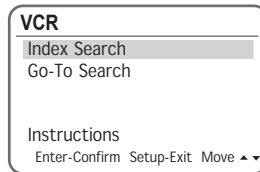

- 4 Use **▲ / ▼** to select "Index Search," then press **ENTER**.
- 5 Press **REW** or **FF** to scan backward or forward for index marks.

OR

Use **▲ / ▼** to select a specific index number, and press **ENTER**.

- 6 The DVD Recorder+VCR rewinds or fast-forwards to the desired index mark.
- 7 Press **SETUP** to exit.

#### Go-To Search

Searches for specific times on your videotape.

- 1 Press **SETUP**.
- 2 Use **◀ / ▶** to select "Preferences."
- 3 Use **▲ / ▼** to select "VCR," then press **ENTER**.
- 4 Use **▲ / ▼** to select "Go-To Search," then press **ENTER**.
- 5 Use **▲ / ▼** to select a specific time on your tape.
- 6 Press **REW** or **FF** to start scanning backward or forward to the specified counter position.
- 7 Press **SETUP** to exit.

## 6 - Advanced Settings (cont.)

### System Information

The Systems Info menu allows you to view the version number of your DVD Recorder+VCR in case service is required.

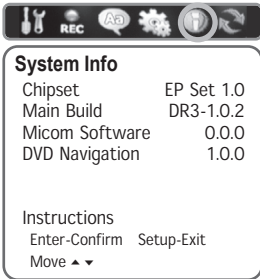

- 1 Press **SETUP**.
- 2 Use ◀ / ▶ to select "System Info."
- 3 Press **SETUP** to exit.

### Restoring Defaults

The Restore Defaults menu allows you to reset the unit to its original factory settings.

- Some options cannot be reset, including Parental Controls, Password, and Country Code.

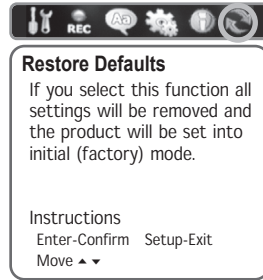

- 1 Press **SETUP**.
- 2 Use ◀ / ▶ to select "Restore Defaults," then press **ENTER**.
- 3 Use ▲ / ▼ to select Yes or No then press **ENTER**.
  - If you select Yes, the DVD Recorder+VCR will revert to its original factory settings.
  - After Restoring Defaults the DVD Recorder+VCR powers off. When you turn it on again, the Initial Setup menu appears; see page 17. You must set the country, language, channel, and clock settings again.

## 7 - Help

### Troubleshooting

SYMPTOM	CAUSE	SOLUTION
No power.	<ul style="list-style-type: none"> <li>Power cord disconnected.</li> </ul>	<ul style="list-style-type: none"> <li>Plug power cord securely into wall outlet.</li> </ul>
No picture.	<ul style="list-style-type: none"> <li>TV not set to receive DVD Recorder+VCR signal output.</li> <li>Video cable not connected securely.</li> <li>TV power turned off.</li> </ul>	<ul style="list-style-type: none"> <li>Select appropriate video input on TV so picture from DVD Recorder+VCR appears on TV screen.</li> <li>Connect video cable securely.</li> <li>Turn on TV.</li> </ul>
No sound.	<ul style="list-style-type: none"> <li>Equipment connected with audio cable not set to receive DVD Recorder+VCR signal output.</li> <li>Audio cables not securely connected.</li> <li>Power on equipment connected with audio cable turned off.</li> <li>Audio cables damaged.</li> </ul>	<ul style="list-style-type: none"> <li>Select correct input mode on audio receiver to hear sound from DVD Recorder+VCR.</li> <li>Connect audio cables securely.</li> <li>Turn on equipment connected with audio cable.</li> <li>Replace with new ones.</li> </ul>
Poor playback picture.	<ul style="list-style-type: none"> <li>Disc is dirty.</li> <li>Tape heads are dirty.</li> <li>Tape is a rental or was recorded on another VCR.</li> </ul>	<ul style="list-style-type: none"> <li>Clean disc.</li> <li>Clean video heads.</li> <li>Use <b>TRACKING+/-</b> for manual adjustment while tape is playing.</li> </ul>
Playback does not start.	<ul style="list-style-type: none"> <li>No disc inserted.</li> <li>No tape inserted.</li> <li>Unplayable disc inserted.</li> <li>Disc placed upside down.</li> <li>Disc not placed within guide.</li> <li>Disc is dirty.</li> <li>Parental Control level set.</li> </ul>	<ul style="list-style-type: none"> <li>Insert disc or tape (check that disc indicator on front panel display is lit.)</li> <li>Insert playable disc (check disc type, color system, and regional code.)</li> <li>Place disc with playback side down.</li> <li>Place disc on disc tray correctly inside the guide.</li> <li>Clean disc.</li> <li>Cancel Parental Control function or change rating level.</li> </ul>
Picture from external input distorted.	<ul style="list-style-type: none"> <li>Video signal from external component is copy-protected.</li> </ul>	<ul style="list-style-type: none"> <li>Cannot connect component via the DVD Recorder+VCR. Connect component directly to your TV.</li> </ul>
Some channels skipped when using CH ▲ ▼ .	<ul style="list-style-type: none"> <li>Skipped channels were deleted with Add/Remove Channels feature.</li> </ul>	<ul style="list-style-type: none"> <li>Use Add/Remove Channels to restore channels; see page 31.</li> </ul>
Picture/sound from broadcasting channel weak or missing.	<ul style="list-style-type: none"> <li>Antenna or cables are loose.</li> <li>Wrong signal type selected in DVD Recorder+VCR Setup menu.</li> </ul>	<ul style="list-style-type: none"> <li>Tighten connections or replace cable.</li> <li>Try all signal type options (TV/CATV); see page 30.</li> </ul>
Camcorder image not shown.	<ul style="list-style-type: none"> <li>Camcorder is off.</li> </ul>	<ul style="list-style-type: none"> <li>Turn camcorder on and operate properly.</li> </ul>
Camcorder image via A/V input to DVD Recorder+VCR not shown on TV screen.	<ul style="list-style-type: none"> <li>DVD Recorder+VCR's source not set to LINE1/LINE2.</li> </ul>	<ul style="list-style-type: none"> <li>Press INPUT to select AV input channel (LINE1/LINE2).</li> </ul>

## 7 - Help (cont.)

### Troubleshooting (cont.)

SYMPTOM	CAUSE	SOLUTION
Can't play disc recorded on this DVD Recorder+VCR on another DVD player.	<ul style="list-style-type: none"> <li>• Disc was not finalized (or not made compatible if using a DVD+RW).</li> <li>• Some players will not play even a finalized disc.</li> <li>• Discs recorded with copy-once material cannot be played on other players.</li> </ul>	<ul style="list-style-type: none"> <li>• Finalize disc; see page 27.</li> <li>• No solution.</li> <li>• No solution.</li> </ul>
Cannot record or did not record successfully.	<ul style="list-style-type: none"> <li>• Insufficient blank space remaining on disc.</li> <li>• Source you are trying to record is copy-protected.</li> <li>• When setting the recording channel, the channel is tuned on your TV's tuner.</li> </ul>	<ul style="list-style-type: none"> <li>• Use another disc.</li> <li>• Cannot record the copy-protected source.</li> <li>• Select the channel on the DVD Recorder+VCR's built-in TV tuner.</li> </ul>
Timer Recording not possible.	<ul style="list-style-type: none"> <li>• Clock not set to correct time.</li> <li>• Timer has been programmed incorrectly.</li> <li>• TIMER indicator light does not appear after programming timer.</li> </ul>	<ul style="list-style-type: none"> <li>• Set clock to correct time; see page 31.</li> <li>• Reprogram Timer; see page 25.</li> <li>• Reprogram Timer.</li> </ul>
No stereo sound during recording and/or playback.	<ul style="list-style-type: none"> <li>• TV not Stereo-compatible.</li> <li>• Broadcast program not in stereo format.</li> <li>• DVD Recorder+VCR A/V Out jacks not connected to TV A/V In jacks.</li> <li>• DVD Recorder+VCR Audio/Video Out not selected for viewing at TV.</li> <li>• DVD Recorder+VCR's TV audio channel is set to SAP or MONO.</li> </ul>	<ul style="list-style-type: none"> <li>• No solution.</li> <li>• No solution.</li> <li>• Make A/V connections. Stereo is available only via A/V output from DVD Recorder+VCR.</li> <li>• Select AUX or A/V source as TV input.</li> <li>• Set TV audio channel mode to Stereo.</li> <li>• Press <b>AUDIO</b> repeatedly to change the TV Audio Channel.</li> </ul>
Remote control does not work properly.	<ul style="list-style-type: none"> <li>• Remote control not pointed at remote sensor of DVD Recorder+VCR.</li> <li>• Remote control too far from DVD Recorder+VCR.</li> <li>• Obstacle in path of remote control and DVD Recorder+VCR.</li> <li>• Batteries in remote control are dead.</li> <li>• Remote control is locked.</li> </ul>	<ul style="list-style-type: none"> <li>• Point remote control at remote sensor of DVD Recorder+VCR.</li> <li>• Operate remote control within 23 ft (7m).</li> <li>• Remove obstacle.</li> <li>• Replace batteries.</li> <li>• Press and hold POWER key on front panel for over 5 seconds.</li> </ul>

## 7 - Help (cont.)

### Technical Specifications

#### General

Power requirements	AC 120V, 60 Hz
Power consumption	34W
Dimensions (approx.)	16.9 x 3.54 x 14.0 inches (430 x 91 x 354 mm) (w x h x d)
Mass (approx.)	13.5 lbs (6.18 kg)
Operating temperature	41°F to 95°F (5°C to 35°C)
Operating humidity	5% to 90%
Signal system	NTSC

#### Recording

Recording formats	DVD Video Recording, DVD-VIDEO
Recordable discs	DVD+R, DVD+RW
Recordable time	DVD ; Approx. 1 hour (HQ mode), 2 hours (SP mode), 4 hours (EP mode), 6 hours (SLP mode)
	VCR ; SP: 2 hours (T-120), SLP: 6 hours (T-120)/8 hours (T-160)
Video sampling frequency	27MHz
Video compression format	MPEG 2
Audio sampling frequency	48kHz
Audio compression format	MPEG1 Layer2

#### VCR Specifications

Head system	4 Head Video, 2 Head Hi-Fi helical scan azimuth system
Timer	12-hour display type with AM, PM
Tape speed	SP: 33.35 mm/sec, SLP: 16.67 mm/sec, EP: 11.12 mm/sec
Tape width	12.7 mm
Rewind time	less than 2 minutes (T-120)
Antenna	75 ohms (VHF/UHF)
VHF output signal	Channel 3 or 4 (Switchable)
Channel coverage	VHF: 2-13, UHF: 14-69, CATV: 1-125 (4A, A-W, W+1 - W+84, A-5 - A-1)
Frequency range	20Hz to 20kHz
Signal-to-noise ratio	43 dB
Dynamic range	75 dB
Channel separation	45 dB

#### DVD Specifications

Laser system	Semiconductor laser, wavelength 650 nm
Frequency response	DVD (PCM 48 kHz): 8 Hz to 22 kHz, CD: 8 Hz to 20 kHz
Signal-to-noise ratio	More than 95 dB
Harmonic distortion	Less than 0.008%
Dynamic range	More than 90 dB

#### Inputs

ANTENNA IN	Antenna or CATV input, 75W
VIDEO IN	1.0 Vp-p 75W, sync negative, RCA jack x 2
AUDIO IN	-6 dBm more than 47 k, RCA jack (L, R) x 2
DV IN	4 pin (i.LINK/IEEE 1394 standard)

#### Outputs

VIDEO OUT	1 Vp-p 75W, sync negative, RCA jack x 1
S-VIDEO OUT (Y)	1.0 V (p-p), 75W, negative sync, Mini DIN 4-pin x 1 (C) 0.286 V (p-p) 75W (Y) 1.0 V (p-p), 75W, negative sync, RCA jack x 1
COMPONENT VIDEO OUT (PROGRESSIVE SCAN)	(Pb)(Pr) 0.7 V (p-p), 75W, RCA jack x 2
Audio output (digital audio)	0.5 V (p-p), 75W, RCA jack x 1
Audio output (analog audio)	1.1 Vrms (1 kHz, -6 dB), 600W, RCA jack (L, R) x 2
RF OUT	Channel 3 or 4 (Switchable)

*Design and specifications are subject to change without notice.*



## 7 - Help (cont.)

### Disc Handling & Maintenance

#### Handling Precautions

- Hold the disc by the edges so the surface will not be soiled with fingerprints.
- Fingerprints, dirt and scratches can cause skipping and distortion.
- Do not write on the label side with a ball-point pen or other writing utensil.
- Do not use record cleaning sprays, benzene, thinner, static electricity prevention liquids, or any other solvent.
- Be careful not to drop or bend the disc.
- Do not insert more than one disc in the disc tray.
- Do not try to close the disc tray when the disc is not installed properly.
- Be sure to store the disc in its original case when not in use.

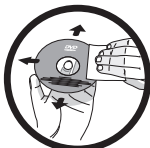

#### If the surface is soiled

- Wipe gently with a soft, damp (water only) cloth.
- When wiping discs, always move the cloth from the center hole toward the outer edge. (If you wipe the disc using a circular motion, circular scratches are likely to occur, which will cause noise.)

#### If the disc is brought from a cold to a warm environment, moisture may form on the disc

- Wipe moisture off with a soft, dry, lint-free cloth before using the disc.

#### Improper disc storage

You can damage discs if you store them in the following places:

- Areas exposed to direct sunlight
- Humid or dusty areas
- Areas directly exposed to a heat outlet or heating appliance

#### Disc which cannot be played with this DVD Recorder+VCR

- CD-ROM (Application Program)
- CVD
- Non-Region 1 encoded discs.

#### Maintenance

- Be sure to turn the unit off and disconnect the AC power cord before maintaining the unit.
- Wipe this unit with a dry soft cloth. If the surfaces are extremely dirty, wipe clean with a cloth which has been dipped in a weak soap-and-water solution and wrung out thoroughly, and then wipe again with a dry cloth.
- Never use alcohol, benzene, thinner, cleaning fluid or other chemicals. And do not use compressed air to remove dust.

#### Power cord protection

To avoid any malfunctions of the unit, and to protect against electric shock, fire or personal injury, please observe the following:

- Hold the plug firmly when connecting or disconnecting the AC power cord.
- Keep the AC power cord away from heating appliances.
- Never put any heavy object on the AC power cord.
- Do not attempt to repair or reconstruct the AC power cord in any way.

#### Placement

Avoid placing the unit in areas of:

- direct sunlight or heating radiators, or closed automobiles
- high temperature (over 95°F) or high humidity (over 90%)
- significant dust as the internal parts may be seriously damaged.

#### Non-use periods

When the unit is not being used, turn it off. When left unused for a long period of time, the unit should be unplugged from the household AC outlet.

#### No fingers or other objects inside

- Touching internal parts of this unit is dangerous, and may cause serious damage to the unit. Do not attempt to disassemble the unit.
- Do not put any foreign object in the disc tray.

#### Keep away from water

- Keep the unit away from flower vases, tubs, sinks, etc. If liquids are spilled into the unit, serious damage could occur.

#### Keep away from magnets

Never bring a magnet or magnetized object near the unit.

#### Stacking

- Place the unit in a horizontal position, and do not place anything heavy on it.

#### Condensation

Moisture may form on the lens in the following conditions:

- immediately after a heater has been turned on
- in a steamy or very humid room
- when the unit is suddenly moved from a cold environment to a warm one

If moisture forms inside this unit, it may not operate properly. In this case, turn on the power and wait about one hour for the moisture to evaporate.

#### If there is noise interference on the TV while a broadcast is being received

Depending on the reception condition of the TV, interference may appear on the TV monitor while you watch a TV broadcast and the unit is left on. This is not a malfunction of the unit or the TV. To watch a TV broadcast, turn off the unit.

### YesDVD™ Terms & Conditions

#### IMPORTANT NOTICE

- READ BEFORE OPERATING THE UNIT AND USE OF THE TECHNOLOGY
- PLEASE CAREFULLY READ THE TERMS AND CONDITIONS OF THIS LICENSE AGREEMENT BEFORE OPERATING THE UNIT AND USING THE TECHNOLOGY.
- OPENING THIS PACKAGE AND USE OF THE TECHNOLOGY INDICATES YOUR ACCEPTANCE OF THESE TERMS AND CONDITIONS.

#### TERMS AND CONDITIONS

YesVideo, Inc. (YesVideo) and Customer agree that the following terms and conditions apply to the license granted under this Agreement (the "Agreement") effective on delivery of the software (the "Effective Date").

##### 1.0 SOFTWARE LICENSE.

- 1.1 Rights Granted. Subject to the terms and conditions of this Agreement, YesVideo grants Customer a perpetual, non-exclusive, non-transferable license to use the software program YesDVD (in object code only "Software") and any corresponding user manuals and documentation ("Documentation", Software and Documentation referred to together as "Technology"), to produce YesDVD products on DVD recorders from Customers home video tapes only. The term "Technology" shall include any corrections, enhancements, updates or other modifications delivered to Customer.
- 1.2 Copying. Customer may not make any copies of the Technology. Customer shall have no right to copy in whole or in part the Software and the Documentation unless permitted in writing by YesVideo. Any and all copies of the Software and the Documentation made by the Customer are the exclusive property of YesVideo.
- 1.3 License Restrictions. Except as allowed under this Agreement, Customer agrees not to reproduce, copy, modify, translate, reverse engineer, disassemble, de-compile or otherwise attempt, or permit others to attempt, to discover the source code of the Software, in whole or in part, except to the extent that such prohibition is restricted by applicable law. Customer agrees not to use the Software in any way to design or develop a competing software product. Customer shall not permit any parent, subsidiaries, affiliated entities or third parties to use the Software and Documentation without the prior written permission of YesVideo. Customer

shall not resell or otherwise use the Software for any commercial or retail applications.

- 1.4 Software Ownership. Customer acknowledges that the Software and its sequence, structure and organization is proprietary to YesVideo and that YesVideo retains exclusive ownership of the Technology. Customer agrees that YesVideo owns all intellectual and proprietary rights, including but not limited to patent, copyright, trade secret, trademark, and other proprietary rights, in and to the Technology and any corrections, bug fixes, enhancements, updates or other modifications, including custom modifications, to the Technology, whether made by YesVideo or any third party. Customer only has the right to use the Technologies as expressly permitted under this Agreement.
- 1.5 Equitable Remedies. Customer agrees that YesVideo's proprietary information is unique in nature and that it would be inadequate to measure only the monetary damages associated with any breach by the Customer of any of the terms and conditions of this Agreement. Accordingly, Customer agrees that if Customer breaches this Agreement, in addition to any other right or remedy available to YesVideo, YesVideo has the right to obtain an injunction from a court of competent jurisdiction restraining such breach or threatened breach and to specific performance of any such provision of this Agreement. Customer further agrees that no bond or security shall be required to obtain such equitable relief and Customer hereby consents to the issuance of such injunction and to the ordering of such specific performance.
- 2.0 TERM AND TERMINATION. This Agreement will commence on the Effective Date. The Agreement shall automatically terminate if Customer does not comply with any of the terms and conditions of this Agreement. Sections 1.4 ("Software Ownership"), Section 1.5 (Equitable Remedies"), 2 ("Term and Termination"), 3 ("Warranties"), 4 ("Limitation of Liability"), and 6 ("General Provisions") shall survive any termination of this Agreement. Upon termination of this Agreement, Customer will (i.) cease all use of the Technology and (ii.) promptly destroy or return to YesVideo the originals and all copies of the Technology, regardless of form or media.
- 3.0 WARRANTIES.
- 3.1 Software. For the first thirty (30) days after delivery of the Software to Customer YesVideo warrants to Customer that the

## 7 - Help (cont.)

unmodified Software will substantially conform to the Documentation and be free of physical defects, when properly used on the appropriate equipment. YesVideo does not warrant that the Software will meet Customer's requirements or that operation of the Software will be uninterrupted or error-free. This warranty does not cover damage caused by improper use or neglect. The Technology is furnished "AS IS" and without warrant as to the performance or results that customer may obtain by using the Technology. To obtain the warranty service during the thirty day warranty period Customer may return the defective Technology with a description of the Problem to YesVideo. The defective Technology will be replaced during this period at no additional charge.

- 3.2 No Other Warranties. This limited warranty states YesVideo's sole obligation, and Customer's exclusive remedy if the Software does not conform to the Documentation. Except as specified in this Software License Agreement, YesVideo makes no express, implied or statutory warranties to Customer and disclaims all warranties of merchantability, fitness for a particular purpose and non infringement of third party rights. No other person is authorized to make written or oral warranties on behalf of YesVideo. If local law precludes the exclusion of implied warranties, such exclusion may not apply to customer.
- 4.0 LIMITATION OF LIABILITY. YesVideo will have no liability to Customer for any indirect, incidental, special, exemplary or consequential damages (including but not limited to lost profits or loss of data or use), whether based in contract, tort, strict liability or any other legal theory, even if YesVideo has been advised of the possibility of or has knowledge of the potential loss or damages. No action, regardless of form, shall be brought by Customer against YesVideo more than one (1) year after the cause of the action has occurred. If the above exclusion of incidental and consequential damages is precluded by local laws, such exclusion may not apply to Customer.
- 8.5.0 UNITED STATES GOVERNMENT PURCHASES. The Software and Documentation are "commercial computer software" and "commercial computer software documentation," respectively, as such terms are used in 48 C.F.R. 12.212 of the Federal Acquisition Regulations ("FAR") and its successors and 48 C.F.R. 227.7202-1 through 227.7202-4 (June 1995) of the

Department of Defense FAR Supplement and its successors. All U.S. government Customers acquire the Software and the Documentation with only those rights set forth in this Agreement.

### 6.0 GENERAL PROVISIONS.

- 6.1 Notices. Any notice required or permitted by this Agreement shall be in writing and shall be delivered as follows with notice deemed given as indicated: (i.) by personal delivery when delivered personally; (ii.) by overnight courier upon written verification of receipt; (iii.) by teletype or facsimile transmission upon acknowledgment of receipt of electronic transmission; or (iv.) by certified or registered mail, return receipt requested, upon verification of receipt. Notice shall be sent to the addresses of each party's corporate headquarters, or such other address as either party may specify in writing.
- 6.2 Assignment and Successors. This Agreement and the Technology may not be transferred, sublicensed, sold, or otherwise transferred by Customer without the prior written consent of YesVideo. This Agreement will bind and inure to the successors and assigns of Customer and YesVideo.
- 6.3 Disputes. This Agreement is governed by the laws of the State of California, without application of the principles of conflicts of laws. The United Nations Convention on Contracts for the International Sale of Goods shall not apply to this Agreement. In the event of a dispute, the prevailing party is entitled to recover reasonable legal fees and court costs.
- 9.7 Interpretation of Agreement. Neither the failure nor any delay of YesVideo to exercise a right, remedy or privilege under this Agreement shall operate as a waiver thereof, nor shall any single or partial exercise of a right, remedy or privilege by YesVideo preclude any further exercise of the same. The waiver by either party of a breach of or right under this Agreement will not constitute a waiver of any other breach or right. In the event that any provision of this Agreement is held to be invalid, illegal or unenforceable, the remaining provisions will continue in full force and effect. This Agreement may only be amended, modified or waived by written documents signed by authorized representative of YesVideo. This Agreement is the complete agreement between the parties regarding this subject matter and supersedes all previous or contemporaneous agreements, proposals and communications, written and oral.

## 7 - Help (cont.)

### GoVideo Limited Warranty

*PLEASE RETAIN YOUR RECEIPT  
IT WILL BE REQUIRED IF WARRANTY  
SERVICE IS NEEDED.*

#### Who Provides the Limited Warranty

During the warranty period, the GoVideo Warranty Administrator will honor service for 90 days labor, 1 year parts from the original date of consumer purchase. See below for Commercial, Industrial or Educational use coverage. Remote controls are warrantied for 90 days from the date of purchase.

#### Who is Protected

This warranty protects the original consumer owner of this GoVideo product.

#### What is Covered and How Long

This warranty covers internal operating parts and service/labor to repair or replace covered parts in this GoVideo product for 90 days labor, 1 year parts, from the date of purchase, defined as follows: (1) Original Consumer Retail Purchase; (2) First Rental Purchase Agreement; or (3) First Lease Purchase Agreement (the "Warranty Period"). Labor and replacement parts supplied during the Warranty Period are covered only for the remaining portion of the original Warranty Period. The GoVideo Warranty Administrator shall have no liability for service under this warranty if non-OEM (Original Equipment Manufacturer) replacement parts are used in the repair of your GoVideo product.

#### What the Owner Must Do If Service is Required

Please contact our customer service department at 1-800-736-7679 to repair or replace your product, at GoVideo's option, if it proves to be defective in material or workmanship under normal use, during the warranty period listed above, effective from the date of original consumer purchase of the product. Repaired or replacement units are warrantied for the remaining period of the original warranty. Please retain dated sales receipt. Within the warranty period, the customer pays for inbound shipping charges and GoVideo pays return shipping charges.

#### Other Warranty Coverage

Commercial, Industrial or Educational use has the same warranty coverage as stated in this warranty.

#### What are the Exceptions

This warranty does **not** cover: (1) Normal maintenance service, such as cleaning. (2) Damage from misuse, abuse neglect or accident, natural disasters or Acts of God. (3) Cabinetry, decorative parts, A/C adapters, knobs or buttons. (4) The foreign country use of this product. (5) GoVideo product which has been electronically or mechanically modified in any way or incorporated into other products. (6) Installation and setup service adjustments. (7) Owner instruction. Your Owner's Guide provides information regarding operating instructions and user controls. For additional information, contact your authorized GoVideo dealer.

GoVideo is not responsible for any shipping, handling or insurance charges.

This Exclusive Limited Warranty excludes all incidental and consequential damages. Some states do not allow the exclusion of incidental and consequential damages, so the above exclusion may not apply to you.

ALL IMPLIED WARRANTIES, INCLUDING IMPLIED WARRANTIES OF MERCHANTABILITY AND FITNESS FOR A PARTICULAR PURPOSE ARE LIMITED IN DURATION TO THE DURATION OF THIS WARRANTY PERIOD. Some states do not allow limitations on how long an implied warranty lasts, so the above limitation may not apply to you.

This Exclusive Limited Warranty gives you specific legal rights and you may also have other rights which vary from state to state.

#### GOVIDEO WARRANTY ADMINISTRATOR

7835 East McClain Drive • Scottsdale, Arizona 85260-1732  
customersupport@govideo.com  
1-800-736-7679

## A

Add/Remove Channels 31  
Adding/Deleting Chapters 29  
Audio CD Playback 21  
Audio Language 33  
Audio Settings 34  
AutoPlay 36  
Auto Channel Search 30  
Auto Chapter 32  
Auto Clock 36

## C

Clock, Set 31  
Compatible Discs 6  
Connections  
  Antenna/Cable 12  
  Audio/Video 13  
  Cable Box/Satellite Receiver 12  
  Component Video 14  
  Digital Camcorder 16  
  Digital Receiver 15  
  External Device 16  
  Progressive Scan 14  
  RF Coaxial 13  
  S-Video 14  
  Stereo/Receiver 15  
Copying  
  DVD to VHS 24  
  One Touch Copy 24  
  VHS to DVD 24

## D

Digital Output 34  
Disc Handling & Maintenance 41  
DoMiNoFX 6  
DVD  
  Basic Playback 18  
  Special Playback Features 18  
Dynamic Range 34

## E

Erasing  
  Disc 27  
  Title 28

## F

Finalizing (DVD+R) 27  
Front Panel 7  
Front Panel Display 8

## G

Go-To Search 36

## H

Hiding/Unhiding Chapters 29

## I

Index Pictures, Changing 29  
Index Search 36  
Initial Setup 17  
Installation Settings 30

## L

Language Settings 32  
Locking/Unlocking a Disc 27

## M

Making Compatible (DVD+RW) 27  
Menu Language 32  
Menu Navigation 30  
Modulator Out 31  
MP3 CD Playback 21

## N

Name, Changing  
  Disc 27  
  Title 28

### O

OSD Language 32  
Overwriting 28

### P

Parental Controls 35  
Parental Level 35  
Password 35  
Picture CD Playback 21  
Preferences 33

### R

Rear Panel 11  
Recording  
    Basic 23  
    External Input 26  
    One Touch 23  
    Timer Recording 25  
Recording Settings 31  
Record Quality  
    DVD 31  
    VCR 31  
Remote Control 9  
Restoring Defaults 37

### S

Safety 4  
Scan Mode 34  
Setup Menu 30  
Splitting a Title 29  
Subtitle Language 33  
System Information 37

### T

Tape Playback 35  
Technical Specifications 40  
Troubleshooting 38  
TV/CATV 30  
TV Aspect 33

### U

Unpacking 6

### V

VCR Reception 35  
VCR Search 36  
VHS Tapes  
    Basic Playback 20  
    Special Playback Features 20  
Video Settings 33  
Virtual Surround 34

### W

Warranty 44

### Y

YesDVD  
    About 6,22  
    Creating 22  
    Menu Setting 32  
    Requirements 22  
    Terms & Conditions 42



**GO.VIDEO®**